

Operating Instruction Manual

XT-46C

Intelligent Shoe Cover Machine

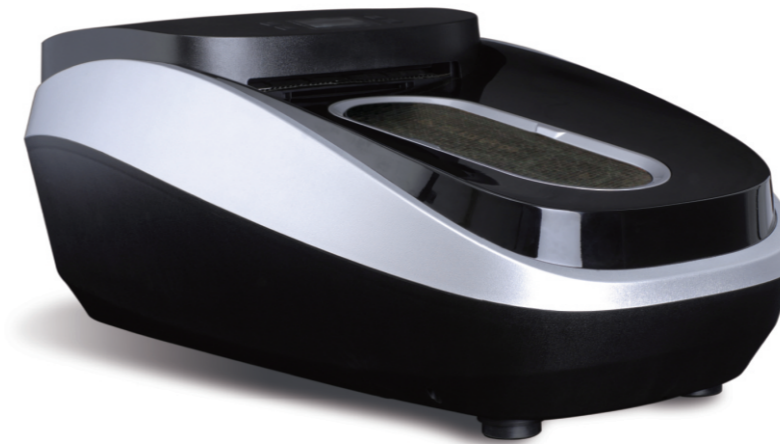

Our Hospitality Begins at Your Feet

Contents

Foreword	2
Unpacking	3
Product Specifications	4
Operation Condition and Safety	5
Usage	6
Control Panel Instructions	8
Precautions	12
Troubleshooting	13

Foreword

- Welcome to use XT-46C Intelligent Shoe Cover Machine. With this helper, it is not necessary to worry about the required clean environment to be polluted by the sole. This instruction will give you operation details and make you quickly get familiar with it and create the fun of using shoe covers.

Unpacking

Unpack it and check for the following necessary items:

XT-46C Intelligent Shoe Cover Machine	1 set
Instruction Manual	1 copy
Power Wire	1 piece
Coiled Film	1 coil

Product Specifications

Model	XT-46C
Type	Intelligent
Dimension	800×445×330
Level Over Ground	20mm
Net Weight	21Kg
Film-feeding Time	4.0sec
Shaping Time	2sec
Maximum Power	1300W
Start Preheating Time	3min
Voltage/Frequency	220±5%V 50Hz
Hot Standby Power	75W
Highest Temperature of Heater	250°C

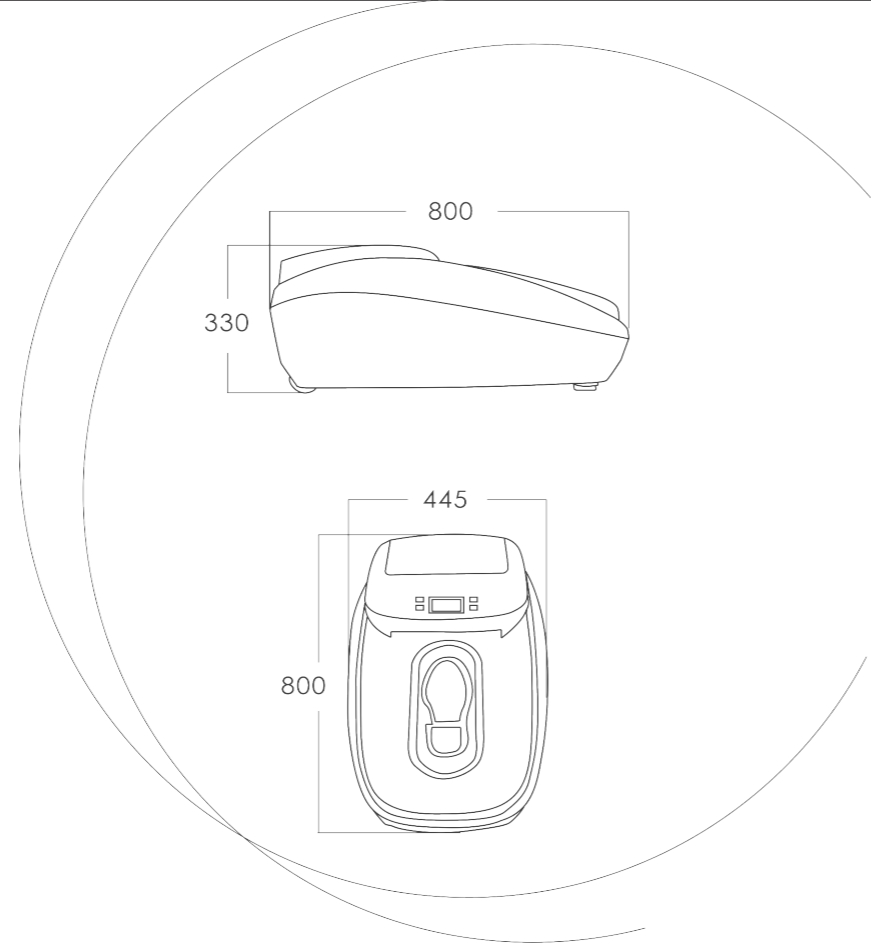

Operation Condition and Safety

Operation Condition

The shoe cover machine shall be used in a clean environment without much high-conductivity fiber. The ambient temperature is 5°C-40°C, and the humidity is not more than 87%. The elevation is less than 1,000m. Film used in shoes cover machine is made of PVC with a certain static electricity. If it is used in the location with the requirement of static electricity, the application scope must be measured.

Safety

In order to ensure the safe usage, please strictly follow the following points:

- Before using XT-46C machine, please read this instruction carefully and follow the operating procedure. Maloperation is not allowed.
- Before power on, please make sure the input voltage meet the 220V-240V requirement.

Warnings: the power supply must have reliably earthed circuit, or it may cause serious personal safety or equipment damage problem.



- In order to avoid machine failure and safety problem, it is prohibited to place the machine in the open or flush the machine with water for cleaning.
- It is prohibited to cover bare foot with film in the machine; It is prohibited to press the footboard when the film is feeding.
- It is prohibited to put any foreign matter into the machine.
- Children are prohibited to use or play the machine alone.
- It is prohibited to walk on the floor where is with water and oil, the attention of anti-skid should be paid.
- During maintenance for the machine or moving the machine. it is necessary to disconnect the power.
- Please often clear up the ventilation slot at the bottom of the machine, in order to avoid blocking and influence the normal operation.

Usage

Turning On

- 1 Connect to the power: Insert both ends of the wire into the indoors socket and the machine socket respectively.
- 2 Press  to turn on the machine

Installation of Coiled Film

- 3 Open the rear cover of the machine, and clean up the burrs and other impurities on the head of the coiled film, ensure that the head of the coiled film is smooth.
- 4 Put the coiled film into the case of the machine horizontally
- 5 Press the film head with one hand and push it into the film outlet medially.
- 6 At the same time, press  with another hand and send the film into the machine until the film is positioned.
- 7 Press the footboard by hand and then loose, and the film will be automatically sent out to working location.
If need to adjust remain of the coiled film, please see "ⓐ Reset Remain" .
If it does not work, press  to turn back the film and repeat the above steps.

Start to Use

When the coiled film is located in the working position, the machine can be used.

- 8 Step on the position with "PRESS" mark.
- 9 When five digits on the screen are lit and a long "beep" sound is produced, that means the shoe cover is shaped.
- 10 Please leave your foot from the footboard, at the same time, the film will automatically stretch out for the next usage.

Turning Off

The machine can be turned off by pressing 

How to Use(Diagrammatic Sketch)

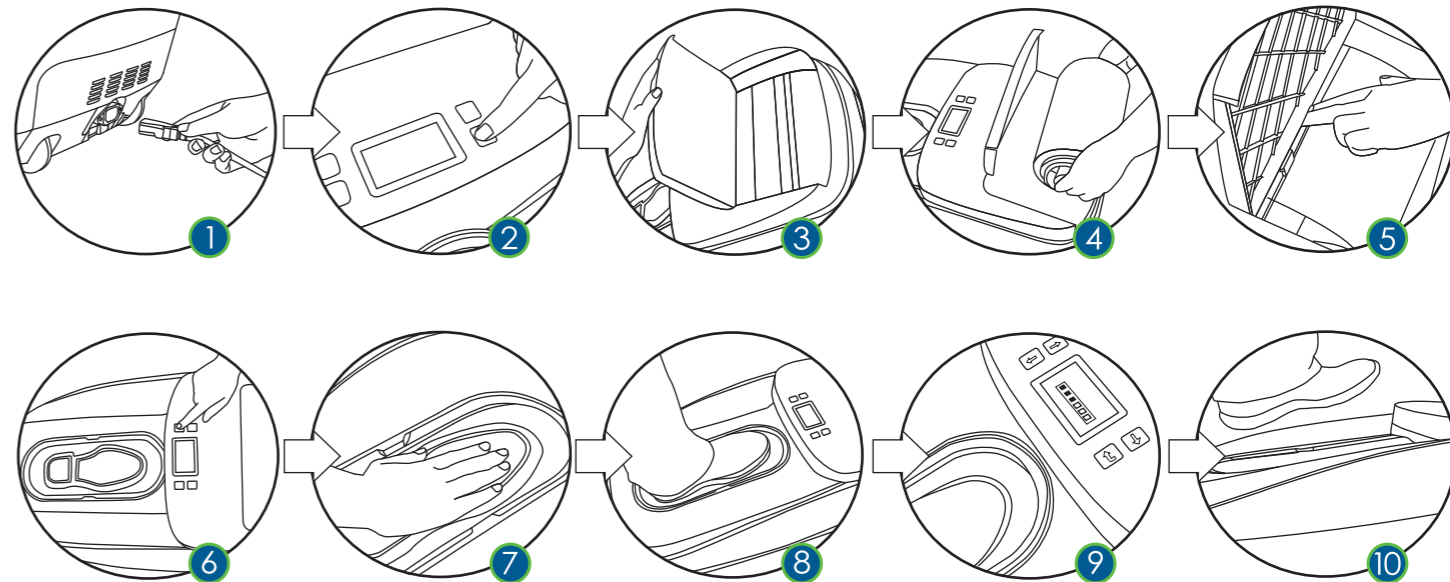

Control Panel Instructions

The control panel is composed of the LCD screen and four function keys, as shown on the right figure.

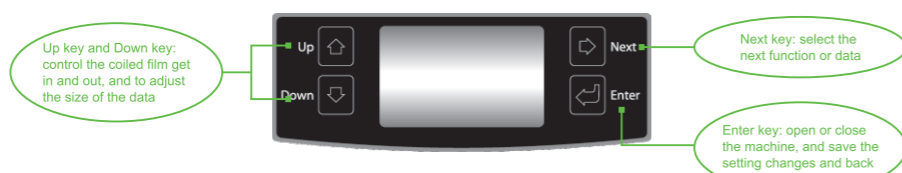

Through the function keys to implement three basic functions: "Shoe Covering", "Warm Wind" and "Data Adjustment", these functions can be looping shown by pressing key. See the following figures

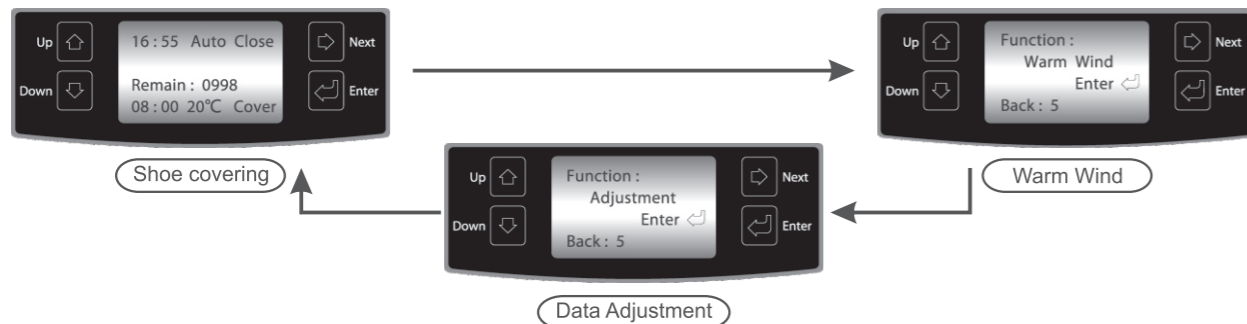

- There are two using functions which are "Shoe Covering", and "Warm Wind".
- The default function is the "Shoe Covering".

On/Off

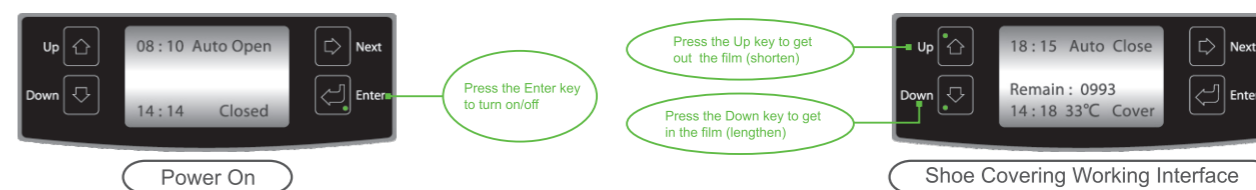

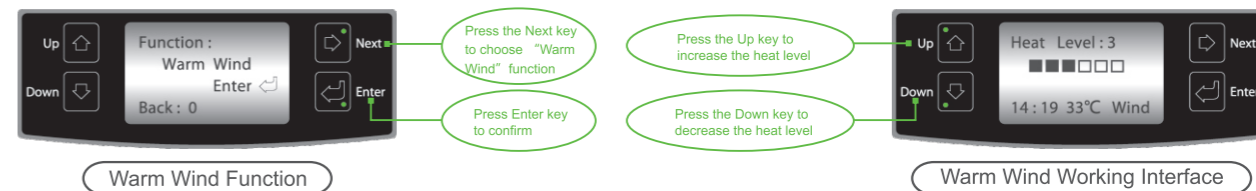

Warm Wind

- 1 This function is used to warm or dry, and the heater is in continuous working state.
- 2 Before using this function, please make sure that there is no film on the footboard. Enter into the "Warm Wind" function, the footboard should be pressed.
- 3 According to the ambient temperature or the requirement, the temperature of the warm wind can be adjusted.



- If you need to quit this function, please press and the machine will be turned off.
- Press , the machine will be turned on and in the "Shoe Covering" function.

Data Adjustment

As shown in the right figure, press  to choose the adjustment function and Press  to enter into the looping submenu of the adjustment function, then press  to select the five sub-functions: "Reset Remain" , "Temp. Control" , "Reset Time" , "Working Time" , "Cancel Timing"

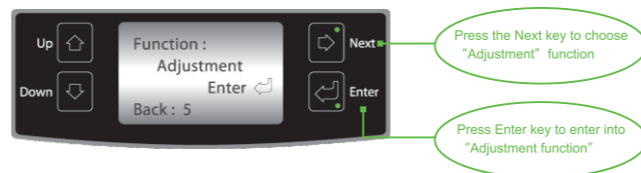

a Reset Remain

According to the number on the coiled film or estimated value of remain, reset remain of the film.



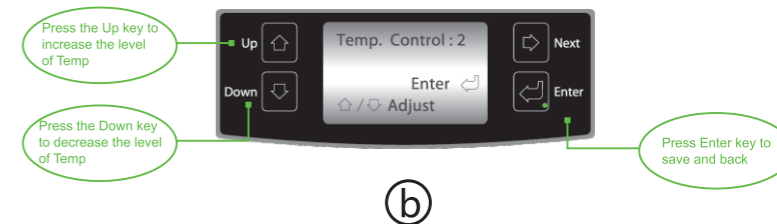

b Temp Control

- This temperature is the temperature of shoe covering.
- There are 9 levels of the temperature that is from 1 to 9, and the default level is 2. According to personal preference, the level of the temperature can be micro-adjusted.





c Reset time

- According to the figure © , adjust the current time.
- Press  or  firstly, to bring the cursor out.



d Working Time

- According to the figure ④, reset the open and close time.
- Press  or  firstly, to bring the cursor out.



e Cancel Timing



Troubleshooting

Failure	Reason	Troubleshooting method
Blocking	External blocking	Pull out the film from the outlet for next usage or withdraw it for another installation.
	Internal blocking	Take down the top cover of the machine(with display screen),clear up the PVC film which is blocked under the cutting knife.
Non-separated film	Serious blocking	Re-install the film roll; Or take down the top cover of the machine(with display screen), clear up the PVC film which is blocked under the cutting knife.
	Non-functional	Contact professional personnel for repair.
Delivered film bias	The film is not normally located	Re-install the film roll according to the instruction, pull the film in place until the film position is correct.
		Open the top cover to check the rotation of the coil. If interference is found, get rid of it.
Delivered direction bias	Natural wind too high	Place the machine in the leeward location
	The air outlet loosened or bias	Contact professional personnel for repair.
Poor shaping effect	Cutting system problem	Contact professional personnel for repair.
	Bottom outlet for ventilation blocked	Check the machine bottom and get rid of it