

# Caring People. Improving Lives

Product catalog  
2024

 acteon



## our vision our mission

---

We believe healthcare is first and foremost about quality of life. Medical treatments are more than just procedures, they restore health, comfort, confidence and happiness and improves life of millions of patients every year. Our vision is to pave the way of a more human-centered healthcare industry based on proactive lifetime care.

To remain at the top of their game and focus on what matters most, healthcare professionals trust integrated solutions that empower them and improve their practices on a daily basis. We provide comprehensive, intuitive workflow solutions that put technology at the service of people and help healthcare professionals restore patients' health effectively, efficiently, and economically.





# About Prophylaxis workflow

This combination of solutions helps dentists easily prevent and diagnose potential dental problems such as periodontal disease and tooth decay. It also allows to perform safe and minimally invasive procedures, providing best care and comfort for patients.



## Diagnosis

To ensure a reliable diagnosis, I need to get a quick and clear view of initial signs of caries, periodontal disease, and other conditions.

**C50**



C50 intraoral camera is the perfect companion for non-invasive and reliable caries detection, thanks to its fluorescent technology.



## Treatment

I wish to carry out fast and accurate treatment, while reducing hand fatigue.

**newtron**



**bliss**

Newtron® P5XS B.LED and Bliss™ is the perfect combo to preserve tissues with efficacy and precision. Less force is needed for more comfort.



## Air polishing

It is important for me to control the progression of the disease, without neglecting the comfort of my patient.

**air-n-go easy**



With Air-N-Go® easy, provide a gentle and effective treatment that limits bleeding. Stains and bacterial plaque are removed even in hard-to-reach areas.



## Follow-up

In order to educate my patients for better treatment acceptance, I need to highlight the results of my dental care.

**C50**



C50 provides a reliable and immediate check of the clinical condition. The images can be shown to the patient and saved to his file.



## Protection

I need to ensure optimal clinical protection for my patients and limit the risk of cross-contamination.



**riskontrol**

Riskontrol® disposable tips are your must-have solution to perform dental care in a safe and clean place. It assures protection, comfort and safety in every daily clinical procedures.



# About Implantology workflow

ACTEON®'s implantology workflow leverages its expertise in different areas of the dental care pathway to help practitioners address some of the challenges associated with implantology to facilitate treatment, reduce treatment costs, increase surgical success, reduce chair time and improve the patient experience.

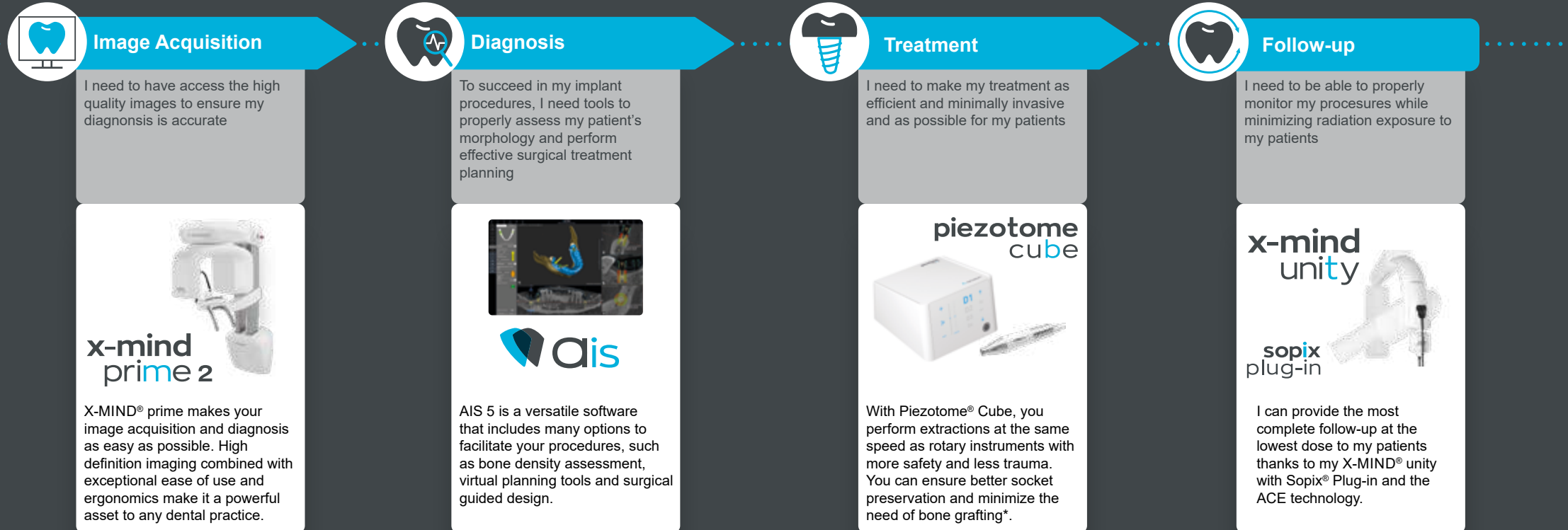

\* Troedhan A, Kurrek A, Wainwright M. Ultrasonic Piezotome surgery: it is a benefit for our patients and does it extend surgery time? A retrospective comparative study on the removal of 100 impacted mandibular 3rd molars. Open Journal of Stomatology. 2011;1:179-184



# About Prosthesis workflow

ACTEON® digital prosthesis workflow allows practitioners to create effectively both functional and aesthetic smile, and to ensure patients' satisfaction. When it comes to complete prosthetic procedures, our top-of-the-range and innovative products help dentists to perform precise and predictable procedures while delivering the best patients' treatment experience.



## Diagnosis

I need to have access to the high quality images to ensure a reliable diagnosis.



X-MIND® prime makes your diagnosis as easy as possible. High definition imaging combined with exceptional ease of use and ergonomics make it a powerful asset to any dental practice.



## Preparation

I need to preserve teeth for a maximal efficiency and an optimal comfort for my patient.

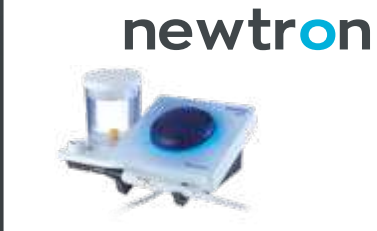

Benefit from Newtron® device ultrasonics technology to achieve precise and effective treatments. Our Perfect Margin™ tips are designed to vibrate efficiently, ensuring maximum and continuous performance for patients' satisfaction.

I need to make my preparation as efficient and minimally invasive as possible for my patients



Achieve painless and effective preparation and facilitate access to the preparation limits with Expasyl™ Exact to guarantee the most natural looking and performing prosthesis.



## Follow-up

I need to highlight the results of my dental care.



The C50 with AIS give patients a clear view of their condition, enabling them to understand the diagnosis and treatment proposals of their dental professional.



## Protection

I need to ensure optimal clinical protection for my patients and limit the risk of cross-contamination.



## riskontrol

Riskontrol® disposable tips are your must-have solution to perform dental care in a safe and clean place. It assures protection, comfort and safety in every daily clinical procedures.



---

# CONTENTS

<b>ACTEON® Imaging</b>	<b>12</b>
<b>ACTEON® Equipment</b>	<b>72</b>
<b>ACTEON® Manual instrumentation</b>	<b>154</b>
<b>ACTEON® Pharma &amp; Specialty consumables</b>	<b>254</b>
<b>ACTEON® OEM</b>	<b>312</b>
<b>ACTEON® Info</b>	<b>346</b>



---

# ACTEON® IMAGING

<b>EXTRAORAL RADIOLOGY</b>	<b>14</b>
<b>INTRAORAL RADIOLOGY</b>	<b>32</b>
<b>INTRAORAL CAMERAS</b>	<b>58</b>

# EXTRAORAL RADIOLOGY

.....

<b>X-MIND® Prime 2</b>	<b>16</b>
<b>X-MIND® Trium True Low Dose</b>	<b>24</b>
<b>AIS</b>	<b>30</b>





## Easy is the new smart!

- ✔ Easy 2D diagnosis
- ✔ Easy patient positioning
- ✔ Easy user interface
- ✔ Easy installation
- ✔ Easy to use

# x-mind prime 2

### RELY ON A COMPLETE SET OF PANORAMIC EXAMS

X-MIND® prime offers a full set of panoramic exams for both adult and child, tailored to meet all your clinical applications:

- Panoramic
- Examination of the temporomandibular joints
- Examination of the maxillary sinuses
- Half-panoramic
- Improved orthogonal panoramic
- Detailed frontal dentition
- Low-dose panoramic
- Bite-wing



### POSITION EASILY AND EFFICIENTLY YOUR PATIENT

Natural face-to-face positioning supported by alignment lasers for correct patient positioning.

X-MIND® prime is based on a fix & lift principle. Whether sitting or standing, the telescopic columns can be directly adjusted using the control panel.

Its open space configuration suits almost all types of patients and is easily accessible for wheelchair users, thanks to its zero footprint design.



### SIMPLE CONTROL PANEL

The simplified control panel, smartly located below the chin support, provides a streamlined and precise patient positioning.

Benefit from an error-free patient positioning thanks to the automated chin rest support recognition.



### THE BRAND VERSION WITH CEPHALOMETRIC ARM

Easy, reliable and safe mobile sensor handling  
CEPHALOMETRIC RADIOGRAPHY

With the ACTEON® X-MIND® prime CEPH, you can extend the fields of application of the device to orthodontic analysis, improving diagnosis and treatment planning.

### 2 AVAILABLE CONFIGURATIONS:

- ✔ X-MIND® prime PAN CEPH
- ✔ X-MIND® prime PAN 3D CEPH

## X-MIND® prime Pan 2D



Orthopantomograph (OPG), 110V–240V, with one CMOS Pan 2D sensor for panoramic imaging.

- 24 adult and child panoramic programs
- Innovative wall-mounted system
- Face-to-face positioning
- Lightest unit on the market
- Installation under an hour by one single technician

ACTEON® Imaging Suite (AIS) streamlines any clinical workflow from patient data management to images acquisition. AIS 2DApp with its clean Imaging interface simplifies the diagnostic phase and allows a better communication with the patient with its portable viewer and dedicated image filters. All Acteon imaging devices can be integrated in the same AIS environment. Installation and user e-manuals, 2 years standard warranty. Not included: light.

Class IIb medical devices (IMQ) - CE0051  
Manufacturer: de Götzen ACTEON® Group - Italy

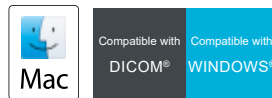

2D Wall-mounted version 110–240V

**W1200001**

## X-MIND® prime Pan 2D CEPH



Orthopantomograph (OPG), 110-240V with single mobile CMOS sensor for panoramic and cephalometric imaging.

Lightweight and compact installation  
39 adult and child acquisition programs  
Accurate and reliable patient positioning  
Fast and easy installation

ACTEON® Imaging Suite (AIS) streamlines any clinical workflow from patient data management to images acquisition. AIS 2DApp with its clean interface simplifies the diagnostic phase and allows a better communication with the patient with its portable viewer and dedicated image filters. All Acteon imaging devices can be integrated in the same AIS environment. Installation and user e-manuals, 2 years standard warranty. Not included: light.

Class IIb medical devices (IMQ) - CE0051  
Manufacturer: de Götzen ACTEON® Group - Italy

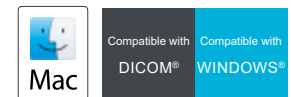

2D version 110-240V

**W1200009**

2D version Double sensor 110-240V

**W1200009.DS**

## X-MIND® prime Pan 3D



Orthopantomograph (OPG), 110V–240V,  
with one CMOS PAN/3D flat panel detector.

- 54 adult and child 2D and 3D programs
- Delivered with AIS 3D app and powerful treatment planning tools
- 4 FOV : 50x50, 85x50, 85x93 and 120x100\* mm
- Innovative wall-mounted system
- Face-to-face positioning
- Lightest unit on the market
- Installation under an hour by one single technician

ACTEON® Imaging Suite (AIS) Software, for visualization and analysis of 2D and 3D acquisitions and treatment planning. AIS 3DAPP PRO included. Compatible with all 2D and 3D imaging products of the group. Installation and user e-manuals, 2 years standard warranty. Not included: Light.

Class IIb medical devices (IMQ) - CE0051  
Manufacturer: de Götzen ACTEON® Group - Italy



3D Wall-mounted version 110–240V + WS + Monitor

**W1200005**

## X-MIND® prime Pan 3D CEPH



Orthopantomograph (OPG), 110-240V equipped with a CMOS PAN/3D flat panel detector and a CMOS 2D CEPH sensor.

69 adult and child 2D PAN/CEPH and 3D programs  
Delivered with AIS 3D app and powerful treatment planning tools  
4 FOV : 50x50, 85x50, 85x93 and 120x100\* mm  
Accurate and reliable patient positioning  
Fast and easy installation  
Software preinstalled.

ACTEON® Imaging Suite (AIS) Software, for visualization and analysis of 2D and 3D acquisitions and treatment planning. AIS 3DAPP PRO included. Compatible with all 2D and 3D imaging products of the group. Installation and user e-manuals, 2 years standard warranty. Not included: Light.

Class IIb medical devices (IMQ) - CE0051  
Manufacturer: de Götzen ACTEON® Group - Italy

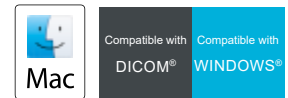

3D version 110-240V + WS + Monitor

**W1200010**

## Spare parts



**Self-standing base kit**  
(including column)

**W1200100**

**Column**  
(not compatible with self-standing base)

**W1200101**

**XMP CEPH FLOOR INSTALLATION KIT**

**W1200121**

**XMP 2D PC**

Windows 10, 64 bits. Nvidia Graphic card.  
no included: network card, monitor, AIS 3D App

**4695489200**

**XMP 3D WORKSTATION**

Windows 10, 64 bits. Nvidia Graphic card, 1 Gbit Ethernet Network card.  
AIS 3D APP.  
not included: monitor

**6604900100**

**22" MONITOR**

DELL P2219H 22" monitor

**4695454900**

**Ethernet board dual port**

**4695488300**

**Chin rests maxillary sinus**

**6604011605**

**Full 2D and 3D panoramic chin rest**

**6604012000**

**Chin rest for edentulous**

**5407098100**

**TMJ support**

**6604011800**

**Temple bar left 2D, 3D & CEPH**

**6101010212**

**Temple bar right 2D, 3D & CEPH**

**6101010112**

**Pan centering bites x50**

**6607090100**

**Disposable bite protective sleeves x100**

**6107110700**

**Double ceph sensor upgrade kit**

**W1205009.DS**

**XMP Extended view 12x10**

**W1200107**



# x-mind trium

true  
low dose

- 3 in 1 System covering Pan, 3D and Ceph exams
- 3D Mapping of bone density
- 4 FOV: From 4x4 to 11x9
- Up to 50% Dose reduction\*
- 75 µm High-resolution image

## FOCUS ON THE REGION OF INTEREST

X-MIND® trium offers you a broad selection of field of view, letting you focus on the region of interest for the target diagnosis and reducing the patient's exposure to X-rays:

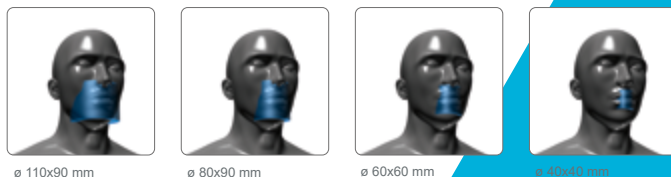

ø 110x90 mm

ø 80x90 mm

ø 60x60 mm

ø 40x40 mm



## DOSE REDUCTION WITHOUT COMPROMISES IN IMAGE QUALITY

### Up to 50%\* dose reduction with TRUE LOW DOSE CBCT

True low dose helps to reduce the X-ray dose while preserving a high image quality. The unique True Low Dose solution is possible thanks to:

### IMAGE ENHANCING ALGORITHM

With the new powerful algorithm, you can now decrease the X-ray settings (up to 50%) with peace of mind. Our Low Dose functionality on the 3D radiographic scan will reveal the same anatomical structures of the X-MIND® trium exam performed with the standard dose.

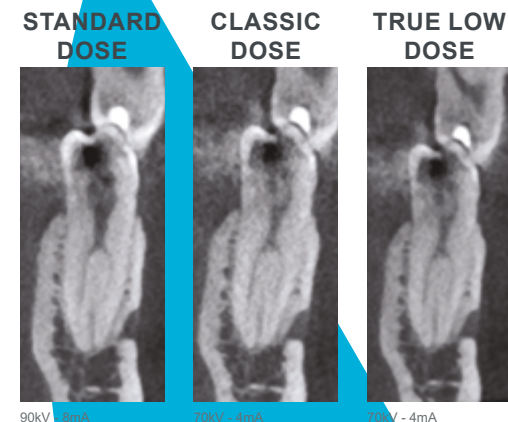

90kV - 8mA

70kV - 4mA

70kV - 4mA

### SMART SLIDE MOVEMENT

X-MIND® trium sensor cassette is sliding closer to the child's head during the exam. This allows to reduce the X-ray dose settings while keeping the exact same image quality as before.

### BEFORE SLIDE MOVEMENT



### AFTER SLIDE MOVEMENT



## AN OUTSTANDING IMAGE QUALITY

The quality of the diagnosis and endodontic treatments improves significantly with the 75 µm resolution of X-MIND® trium.

## X-MIND® trium TLD Pan 3D



Class IIb medical devices (IMQ) - CE0051  
Manufacturer: de Götzen ACTEON® Group - Italy

OrthoPanTomograph (OPG), 115-220V, with Flat Panel Detector for CBCT and panoramic imaging.

- Child-dedicated Panoramic and CBCT programs
- Low dose CBCT programs
- Improved Orthogonality
- TMJ section
- Maxillary Sinus exam
- CBCT FOV Ø40x40, Ø60x60, Ø80x90, Ø110x90

Software preinstalled on the provided workstation and monitor.

ACTEON® Imaging Suite (AIS) Software, for visualisation and analysis of 2D and 3D acquisitions and treatment planning. Includes five licenses for 3D app PRO, the 3D viewer and implant planning application. Compatible with all 2D and 3D imaging products of the group. Installation and user e-manuals, 2 years standard warranty. Not included: Light.

\* The control panel can be placed on the right during installation according to the practitioner's needs

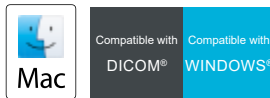

Control panel on the left\*

**W0920010**

## Warranty extensions

Warranty extension for 1 additional year	<b>W0900028</b>
Warranty extension for 2 additional years	<b>W0900029</b>
Warranty extension for 3 additional years	<b>W0900030</b>

## X-MIND® trium TLD Pan 3D CEPH



Class IIb medical devices (IMQ) - CE0051  
Manufacturer: de Götzen ACTEON® Group - Italy

OrthoPanTomograph (OPG), 115-220V, with one CMOS 2D sensor for cephalometry and a flat Panel Detector for CBCT and panoramic imaging.

- Child-dedicated Panoramic and CBCT programs
- Low dose CBCT programs
- Improved Orthogonality
- TMJ section
- Maxillary Sinus exam
- Cephalometric exams
- CBCT FOV Ø40x40, Ø60x60, Ø80x90, Ø110x90

Software preinstalled on the provided workstation and monitor.

ACTEON® Imaging Suite (AIS) Software, for visualisation and analysis of 2D and 3D acquisitions and treatment planning. Includes five licenses for 3D app PRO, the 3D viewer and implant planning application. Compatible with all 2D and 3D imaging products of the group. Installation and user e-manuals, 2 years standard warranty. Not included: Light.

\* The control panel can be placed on the right during installation according to the practitioner's needs

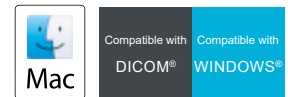

CEPH right, control panel on the left\*

**W0920012**

CEPH left, control panel on the left\*

**W0920233**

## Warranty extensions

Warranty extension for 1 additional year	<b>W0900031</b>
Warranty extension for 2 additional years	<b>W0900032</b>
Warranty extension for 3 additional years	<b>W0900033</b>

## Accessories & spare parts

<b>Pan 2D sensor</b> for OrthoPanTomograph (OPG) (to add a second 2D sensor or for replacement)	<i>W0900036</i>
<b>Ceph 2D sensor</b> for OrthoPanTomograph (OPG) and cephalometry (for replacement)	<i>W0900037</i>
<b>CBCT PLAN sensor</b> for 3D imaging (for replacement)	<i>W0900038</i>
<b>PC Client</b> (no monitor) not included: network card, Monitor, AIS 3D App	<i>W0900040</i>
<b>PC workstation 3D</b> (no monitor) Windows 10, Nvidia graphic card, 1 Gbit Ethernet Network card. not included: monitor	<i>W0900042</i>
<b>PC Workstation 2D</b> Windows 10, monitor network card	<i>W0900246</i>
<b>Upgrade kit for dell 3620 WORKSTATION</b> 1Tb SSD Hard drive - 16Gb RAM - P620 Nvidia GPU (display card)	<i>W0900277</i>
<b>27" Monitor</b> Lenovo P27H-10 27" monitor	<i>W0900141</i>
<b>Remote trigger &amp; 15m cable</b>	<i>W0900091</i>
<b>Ears protections X-MIND® trium</b> (280 pcs) only for arms Ceph	<i>W0900110</i>
<b>Chin rests, bite block, TMJ X-MIND® trium</b>	<i>W0900080</i>
<b>Temple bars left/right X-MIND® trium</b>	<i>W0900071</i>
<b>Sliding bite blocks X-MIND® trium</b> (10 pcs)	<i>W0900142</i>
<b>Bite protections X-MIND® trium</b> (500 pcs)	<i>W0900113</i>



**X-MIND® TRIUM Self Standing Base**

*W0900236*





## ACTEON® Imaging Suite

ACTEON® Imaging Suite

W0900046

## AIS 3D App 5.0

AIS 3D APP 5.0 Pro

W1000024

AIS 3D APP 5.0 Design 1 year license, for the first year

W1000025

AIS 3D APP 5.0 Design 1 year license, starting the second year

W1000026

## ACTEON® Imaging Suite - DICOM Licence

Licence AIS DICOM package

W0900153





# INTRAORAL RADIOLOGY

.....

<b>X-MIND® Unity</b>	<b>34</b>
<b>X-MIND® DC</b>	<b>38</b>
<b>PSPIX®<sup>2</sup></b>	<b>44</b>
<b>SOPIX® Plug-in / SOPIX®<sup>2</sup> Plug-in</b>	<b>50</b>
<b>SOPIX® / SOPIX®<sup>2</sup></b>	<b>54</b>
<b>U-SENSE HD / U-SENSE</b>	<b>56</b>



# x-mind unity

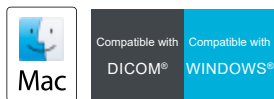

- 0.4 mm focal spot
- Configurable radiological settings (time, mA, kV)
- Ace – Reducing patient dose
- Dosage display
- Top and bottom mounting

X-MIND® unity is pre-wired for the integration of the SOPIX® Plug-in / SOPIX<sup>2</sup> Plug-in digital sensor.

X-MIND® unity is Delivered with a long cone in standard version.

## X-MIND® unity - Mobile



Package including mobile support and X-MIND® unity for mobile support

<b>Mobile support for X-MIND® unity</b>	<b>W0800127</b>
X-MIND® unity for mobile support:	
<b>Mobile support - Long cone</b>	<b>W0800085</b>
<b>Mobile support - Short cone</b>	<b>W0800091</b>
<b>Mobile support - Long square cone</b>	<b>W0800128</b>
<b>Mobile support - Short square cone</b>	<b>W0800129</b>

## X-MIND® unity - Top mounting

<b>Short cone - extensor 0.40m</b>	<b>W0800000</b>
<b>Short cone - extensor 0.80m</b>	<b>W0800001</b>
<b>Short cone - extensor 1.10m</b>	<b>W0800002</b>
<b>Long cone - extensor 0.40m</b>	<b>W0800003</b>
<b>Long cone - extensor 0.80m</b>	<b>W0800004</b>
<b>Long cone - extensor 1.10m</b>	<b>W0800005</b>
<b>Short square cone - extensor 0.40m</b>	<b>W0800102</b>
<b>Short square cone - extensor 0.80m</b>	<b>W0800103</b>
<b>Short square cone - extensor 1.10m</b>	<b>W0800104</b>
<b>Long square cone - extensor 0.40m</b>	<b>W0800006</b>
<b>Long square cone - extensor 0.80m</b>	<b>W0800007</b>
<b>Long square cone - extensor 1.10m</b>	<b>W0800008</b>

## X-MIND® unity - Bottom mounting

<b>Short cone - extensor 0.40m</b>	<b>W0800009</b>
<b>Short cone - extensor 0.80m</b>	<b>W0800010</b>
<b>Short cone - extensor 1.10m</b>	<b>W0800011</b>
<b>Long cone - extensor 0.40m</b>	<b>W0800012</b>
<b>Long cone - extensor 0.80m</b>	<b>W0800013</b>
<b>Long cone - extensor 1.10m</b>	<b>W0800014</b>
<b>Short square cone - extensor 0.40m</b>	<b>W0800105</b>
<b>Short square cone - extensor 0.80m</b>	<b>W0800106</b>
<b>Short square cone - extensor 1.10m</b>	<b>W0800107</b>
<b>Long square cone - extensor 0.40m</b>	<b>W0800015</b>
<b>Long square cone - extensor 0.80m</b>	<b>W0800016</b>
<b>Long square cone - extensor 1.10m</b>	<b>W0800017</b>

## Accessories & spare parts



X-MIND® unity short cone

W0800018



X-MIND® unity long cone

W0800019



X-MIND® unity short square cone

W0800137



X-MIND® unity long square cone

W0800020



X-MIND® unity tubehead

W0800022



X-MIND® unity timer

W0800023



IRIX 70 wall plate  
for X-MIND® unity installation

W0800100

## Spare parts

Extensor 0.40m X-MIND® unity top mounting

W0800009

Extensor 0.80m X-MIND® unity top mounting

W0800010

Extensor 1.10m X-MIND® unity top mounting

W0800011

Extensor 0.40m X-MIND® unity bottom mounting

W0800012

Extensor 0.80m X-MIND® unity bottom mounting

W0800013

Extensor 1.10m X-MIND® unity bottom mounting

W0800014

Extensor pantograph X-MIND® unity

W0800105

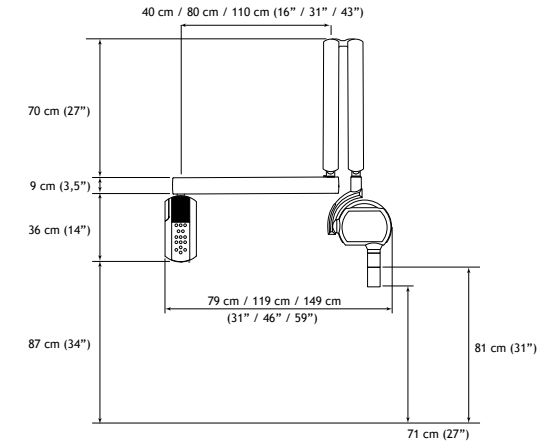
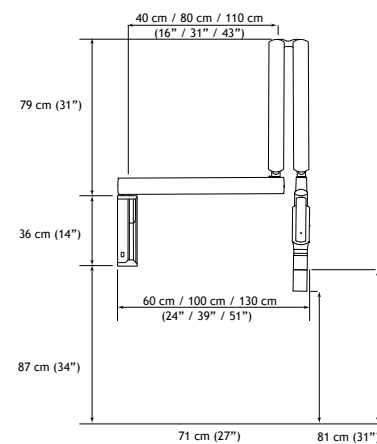
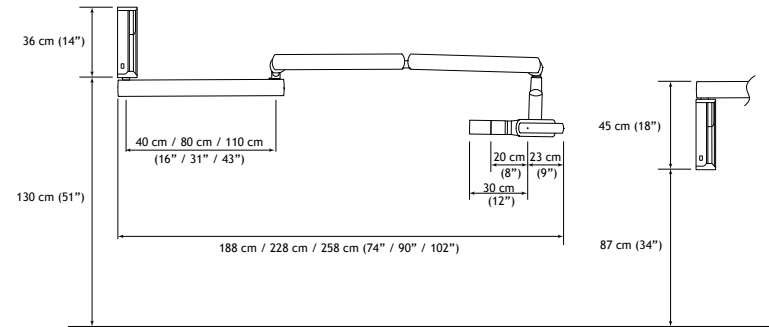

# x-mind dc



- ✔ Long lasting high performance
- ✔ Easy-to-use
- ✔ Flexible installation alternatives for more practice
- ✔ Different cones to improve your experience in all your clinical needs

Delivered with a generator 70KV, a pantograph, an extensor and a timer.



## X-MIND® DC - Mobile



**Mobile support - Long cone** **5.92.23133**

**Mobile support - Square cone** **5.92.23163**

## X-MIND® DC - Top mounting

**Long cone - extensor 0.40m (max. distance 143cm)** **5.92.23137**

**Long cone - extensor 0.80m (max. distance 184cm)** **5.92.23138**

**Long cone - extensor 1.10m (max. distance 212cm)** **5.92.23139**

**Square cone - extensor 0.40m (max. distance 143cm)** **5.92.23167**

**Square cone - extensor 0.80m (max. distance 184cm)** **5.92.23168**

**Square cone - extensor 1.10m (max. distance 212cm)** **5.92.23169**

## X-MIND® DC - Bottom mounting

**Long cone - extensor 0.40m (max. distance 143cm)** **5.92.23130**

**Long cone - extensor 0.80m (max. distance 184cm)** **5.92.23131**

**Long cone - extensor 1.10m (max. distance 212cm)** **5.92.23132**

**Square cone - extensor 0.40m (max. distance 143cm)** **5.92.23160**

**Square cone - extensor 0.80m (max. distance 184cm)** **5.92.23161**

**Square cone - extensor 1.10m (max. distance 212cm)** **5.92.23162**

## X-MIND® DC - Unit

**Long cone - mounting extensor 0.40m** **5.92.23135**

## X-MIND® DC - Ceiling

**Long cone - ceiling mounting extensor 0.40m** **5.92.23136**

(standard Faro column Ø60cm) Ceiling fasteners not included

## Spare parts

	<b>X-MIND® AC tubehead</b>	<b>5.21.23130</b>
	<b>X-MIND® DC tubehead</b>	<b>5.31.23130</b>
	<b>X-MIND® AC timer</b>	<b>5.25.23130</b>
	<b>X-MIND® DC timer</b>	<b>5.35.23130</b>
	<b>Short cone (20cm SSD)</b>	<b>29701195</b>
	<b>Long cone (31cm SSD)</b>	<b>29701197</b>
	<b>Square cone (31cm SSD)</b>	<b>29701199.C</b>
	<b>IRIX 70 wall plate</b> for X-MIND® AC or DC installation	<b>22002350</b>

## Spare parts

	<b>X-MIND® AC pantograph</b>	<b>29700813.C</b>
	<b>X-MIND® DC pantograph</b>	<b>29701006.C</b>
	<b>X-MIND® AC/DC 0.40m extensor</b> bottom mounting	<b>29700380.C</b>
	<b>X-MIND® AC/DC 0.80m extensor</b> bottom mounting	<b>29700378.C</b>
	<b>X-MIND® AC/DC 1.10m extensor</b> bottom mounting	<b>29700379.C</b>
	<b>X-MIND® AC/DC 0.80m extensor</b> with pantograph and wall plate	<b>5.30.00131</b>
	<b>X-MIND® AC/DC 1.10m extensor</b> with pantograph and wall plate	<b>5.30.00132</b>
	<b>X-MIND® AC/DC 0.40m extensor</b> top mounting	<b>29700620.C</b>
	<b>X-MIND® AC/DC 0.80m extensor</b> top mounting	<b>29700621.C</b>
	<b>X-MIND® AC/DC 1.10m extensor</b> top mounting	<b>29700622.C</b>
	<b>X-MIND® AC/DC 0.40m extensor</b> column unit	<b>29700381.C</b>
	<b>X-MIND® AC/DC 0.40m extensor</b> ceiling mounting	<b>29700382.C</b>
	<b>X-MIND® AC/DC wall plate</b> bottom mounting	<b>29700384.C</b>
	<b>X-MIND® AC/DC wall plate</b> top mounting	<b>29700385.C</b>

## Mounting

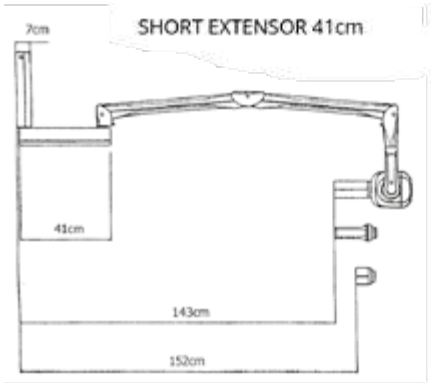

**BRACKET 0.41m**

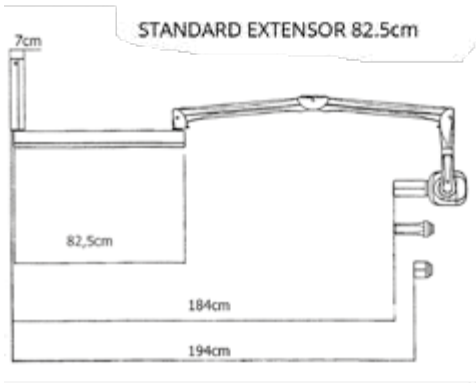

**BRACKET 0.825m**

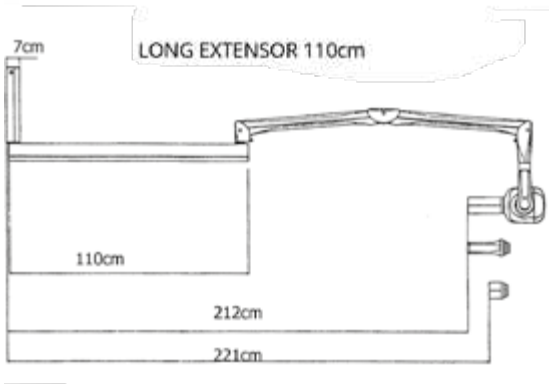

**BRACKET 1.10m**



# pspix2

**By your side,  
to care for  
everyone**

- A striking contrast for an accurate diagnosis
- The most compact PSP scanner on the market
- Touchscreen for intuitive indications
- Elegant design fits within your dental office
- Various sizes for more adaptability

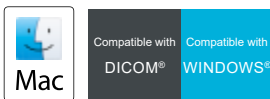

**PSPIX®2 - Digital imaging plate system**

**S\_702\_0013**

with 4 imaging plates (2x size 1, 2x size 2), 200 bags & covers for imaging plate (100x size 1, 100x size 2), an imaging plate storage box, 1 stylus for touchscreen, 10 samples of Soprowipes, 1 power supply 100-240 VAC, 1 Ethernet cable, SOPRO Imaging software and its licence.

Class I medical device - CE - Manufacturer: Sopro ACTEON® Group - France

WINDOWS®	MINIMUM CONFIGURATION REQUIRED
Operating system	Windows® 10 PRO 64bits
Processor	Quadcore 2.6GHz
RAM	8GB
Hard disk	300GB (SSD)
USB port	2 USB2.0 Hi-Speed ports
Graphic card	OPEN GL 2.1 or better alternatively DirectX 9 or 11 Graphics device
USB Chipset	Intel® or NEC® / RENESAS®
Screen resolution	1600x1024
Ethernet board	100Mbps - 1Gbps
MAC®	MINIMUM CONFIGURATION REQUIRED
Computer	MacBook® Pro 13" or iMac® 21.5"
Operating system	macOS Ventura
Processor	Intel® Core i5 or from Apple M1
RAM	8GB
Ethernet board	1Gbps

## Accessories





### Standard imaging plate

	PSPIX®2	PSPIX® 1 <sup>st</sup> generation
	Set of 2	Set of 6
<b>Size 0</b> (22 x 35mm)	 <b>990215</b>	 <b>S_700178</b>
<b>Size 1</b> (24 x 40mm)	 <b>990216</b>	 <b>S_700179</b>
<b>Size 2</b> (31 x 41mm)	 <b>990217</b>	 <b>S_700180</b>
<b>Size 3</b> (27 x 54mm)	 <b>990218</b>	 <b>S_700181</b>

PSPIX®2 imaging plate - Class IIa Medical devices (GMED) - CE0459 - Manufacturer: Sopro ACTEON® Group - France  
 PSPIX® imaging plate - Class IIa Medical devices (Eurofins) - CE0537 - Manufacturer: Soredex - Distributor: Sopro ACTEON® Group

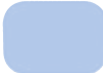

### IDOT™ imaging plate

Numbered plate for better identification. Only for PSPIX® 1<sup>st</sup> generation

	PSPIX® 1 <sup>st</sup> generation
	Set of 6
<b>Size 0</b> (22 x 35mm)	 <b>S_700182</b>
<b>Size 1</b> (24 x 40mm)	 <b>S_700183</b>
<b>Size 2</b> (31 x 41mm)	 <b>S_700184</b>
<b>Size 3</b> (27 x 54mm)	 <b>S_700185</b>









## Accessories

### Protective bag for imaging plate











	PSPIX®2 & PSPIX® 1 <sup>st</sup> generation	
	Set of 250	
Size 0		700342L
Size 1		700343L
Size 2		700344L
Size 3		700345L

### Bag & cover for imaging plate

with integrated cardboard envelop

	PSPIX®2		PSPIX® 1 <sup>st</sup> generation	
	Set of 300		Set of 250	
Size 0		700546		700338L
Size 1		700547		700339L
Size 2		700548		700340L
Size 3		700549		700341L

## Accessories

	<b>Bag &amp; cover for imaging plate start up kit</b> (set of 100 pieces of size 1 and 100 pieces of size 2)	700550
	<b>Imaging plate storage box</b> (without imaging plates)	990219
	<b>Stylus for PSPIX®2 touchscreen</b>	005132
	<b>Cleaning plate for PSPIX®2</b>	990243
	<b>Unit Cover for PSPIX®2</b>	990247
	<b>Autoclavable removable parts for PSPIX®2</b> with 1 removable autoclavable receptacle and 1 autoclavable insertion guide for imaging plates	990241
	<b>Size 4 kit for PSPIX®2</b> with 1 positioning holder (size 4), 3 imaging plates (size 3) and 100 Hygiene Bag (size 4)	990252
	<b>Plastic holder size 4</b>	990251
	<b>Imaging plates size 3</b> (Set of 3)	990248
	<b>Protective bag size 4</b> (Set of 100)	700644



## Accessories

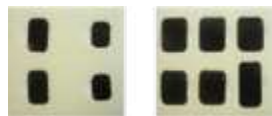

**Starter kit of standard imaging plate<sup>(1)</sup>**  
with 10 standard imaging plate of four different sizes (2x size 0, 2x size 1, 5x size 2 et 1x size 3) for PSPIX®

**S\_700200**



**Starter kit of accessories<sup>(2)</sup>**  
with 100 Hygiene Bag and 100 Protective Cover of each size for PSPIX®

**S\_700201**



**Imaging plate storage box**  
(without imaging plates) for PSPIX®

**S\_700482**



**«Medical device» power supply**  
for PSPIX®

**703004**



**Positioning set for PSPIX®2 & PSPIX® imaging plate**  
with five positioning holders with ring for bitewing and one centring devices

**S\_700195**



**Positioning set for PSPIX®2 & PSPIX® imaging plate<sup>(3)</sup>**  
with two positioning holders with ring for anterior teeth, two positioning holders with ring for posterior teeth and two centring devices

**S\_700196**



**ACTEON® Imaging Suite<sup>(4)</sup> (AIS)**  
USB stick

**990263**

(1) - PSPIX Imagine plate: Class IIa medical devices (Eurofins) - CE 0537 - Manufacturer: Soredex - Distributor: Sopro ACTEON® Group - France

(2) - Class I medical devices - CE - Manufacturer: Sopro ACTEON® Group - France

(3) - Class I medical device - CE - Manufacturer: KerrHawe SA - Distributor: Sopro ACTEON® Group - France

(4) - Class IIb Medical device (IMQ) - CE0051 - Manufacturer: de Gotzen ACTEON® Group - Italy



# sopix plug-in    sopix2 plug-in



**Smart sensor,  
for effortless  
performance**



### SMART DOSE

The ACE® technology protects both the image and your patient from unnecessary exposure.

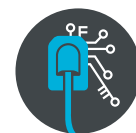

### SMART TECHNOLOGY

Our latest generation of digital sensors provide a sharp X-ray image for an easy reading of the different dental tissues.



### SMART FLOW

Our mobile sensors adapt to all clinical cases, all morphologies and all software, to provide you and your patients greater comfort.



## About our ace technology



Competitor's  
Sensor + generator

X-rays

Excessive X-rays

Over  
exposed



End of X-rays  
emission

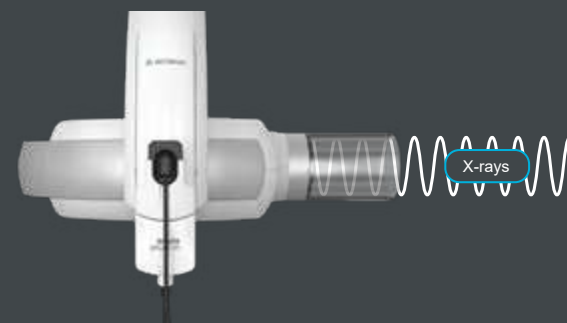

1. End of image  
acquisition

PERFECT  
IMAGE



2. End of X-rays  
emission



Our exclusive ACE® technology protects both your patients and your images from overexposure.

\*Automatic Control Exposure

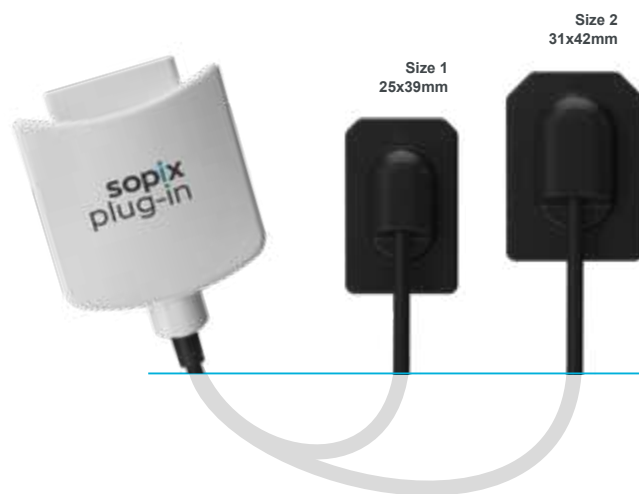

## sopix plug-in

**SOPIX® PLUG-IN size 1** with SOPIX® Plug-in dock

**S\_K60\_1002**

**SOPIX® PLUG-IN size 2** with SOPIX® Plug-in dock

**S\_K60\_1003**

CMOS sensor with optic fiber of 1.5 million of pixels (size 1) or 2.21 millions of pixels (size 2), theoretical resolution of 25pl/mm, actual resolution > 18pl/mm, 0.70m cable. Includes ACE technology (Automatic Control Exposure).

with a sensor holder, 10 sensor sheaths, the ACTEON® Imaging Suite (AIS) software. The sensor can be used with Sopix® Plug-in dock.

Class IIa Medical devices (GMED) - CE0459 - Manufacturer: Sopro ACTEON® Group- France

## TECHNICAL SPECIFICATIONS - WINDOWS®

WINDOWS®	MINIMUM CONFIGURATION REQUIRED
Operating	Windows® 10 PRO 64bits
Processor	Intel® core i5 - 2 Cores 4 thread
RAM	8GB
Hard disk	250GB (SSD)
USB port	2 USB2.0 Hi-Speed ports
Graphic card	OPEN GL 2.1 or DirectX 9 or 11 Graphics device
USB Chipset	Intel® or NEC® / RENESAS®
Screen resolution	1600x1024

## sopix<sup>2</sup> plug-in

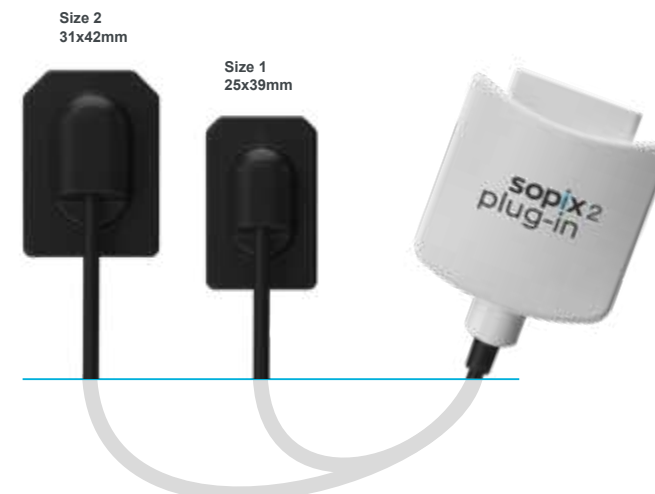

**SOPIX®<sup>2</sup> PLUG-IN size 1** with SOPIX® Plug-in dock

**S\_K60\_1000**

**SOPIX®<sup>2</sup> PLUG-IN size 2** with SOPIX® Plug-in dock

**S\_K60\_1001**

CMOS sensor with optic fiber of 1.5 million of pixels (size 1) or 2.21 millions of pixels (size 2), theoretical resolution of 25pl/mm, actual resolution > 12pl/mm, 0.70m cable. Includes ACE technology (Automatic Control Exposure).

with a sensor holder, 10 sensor sheaths, the ACTEON® Imaging Suite (AIS) software. The sensor can be used with Sopix® Plug-in dock.

Class IIa Medical devices (GMED) - CE0459 - Manufacturer: Sopro ACTEON® Group- France

## TECHNICAL SPECIFICATIONS - MAC®

MAC®	MINIMUM CONFIGURATION REQUIRED
Computer	MacBook® Pro 13" or iMac® 21.5"
Operating system	macOS Ventura
Processor	Intel® Core i5 or from Apple M1
RAM	8GB

# sopix sopix 2

## Smart sensor, for effortless performance



- Striking contrast thanks to FIBER2PIXEL® technology
- High Quality images
- No more overexposed images with ACE technology
- Rounded edges and corners for better comfort

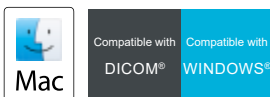

### SOPIX®2



**SOPIX®2 USB2 Sensor size 1**  
high definition

**S\_802\_0008**



**SOPIX®2 USB2 Sensor size 2**  
high definition

**S\_802\_0009**

CMOS sensor with optic fiber of 1.5 million of pixels (size 1) or 2.21 millions of pixels (size 2), theoretical resolution of 25pl/mm, actual resolution > 18pl/mm, 3.70m cable. Includes ACE technology (Automatic Control Exposure).

with a sensor holder, 10 sensor sheaths, the ACTEON® Imaging Suite (AIS) software.

### SOPIX®



**SOPIX® USB2 Sensor size 1**  
standard definition

**S\_802\_3008**

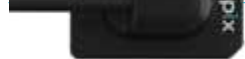

**SOPIX® USB2 Sensor size 2**  
standard definition

**S\_802\_3009**

CMOS sensor with optic fiber of 1.5 million of pixels (size 1) or 2.21 millions of pixels (size 2), theoretical resolution of 25pl/mm, actual resolution > 12pl/mm, 3.70m cable. Includes ACE technology (Automatic Control Exposure).

with a sensor holder, 10 sensor sheaths, the ACTEON® Imaging Suite (AIS) software.

## Accessories



### Positioning set for SOPIX®2/SOPIX® series sensors

with five positioning holders with ring (bitewing, anterior, posterior, endo anterior, endo posterior)

**700042**



### SOPIX®2/ SOPIX® sensor holder

size 1 or Size 2

**926039**



### Sheaths for SOPIX®2/ SOPIX®

(500 pieces in a single pasteboard)  
for size 1 SOPIX®2 series sensors  
for size 2 SOPIX®2 series sensors

**403026**

**403027**



### USB2.0 active repeater cable (Booster)

length: 5m

**700381**



### ACTEON® Imaging Suite<sup>(1)</sup> (AIS)

USB stick

**990263**

(1) - Class IIb Medical device (IMQ) - CE0051 - Manufacturer: de Gotzen ACTEON® Group - Italy

WINDOWS®	MINIMUM CONFIGURATION REQUIRED
Operating	Windows® 10 PRO 64bits
Processor	Intel® core i5 - 2 Cores 4 thread
RAM	8GB
Hard disk	250GB (SSD)
USB port	2 USB2.0 Hi-Speed ports
Graphic card	OPEN GL 2.1 or DirectX 9 or 11 Graphics device
USB Chipset	Intel® or NEC® / RENESAS®
Screen resolution	1600x1024
MAC®	MINIMUM CONFIGURATION REQUIRED
Computer	MacBook® Pro 13" or iMac® 21.5"
Operating system	macOS Ventura
Processor	Intel® Core i5 or from Apple M1
RAM	8GB

# u.sense HD

## u.sense



- Striking contrast for better tissue differentiations
- High resolution images 25lp/mm
- 3 seconds acquisition time
- Direct connection to the computer
- 2 sizes to meet any application needs

### U-SENSE HD



U-SENSE HD Size 1\*

W1300003

U-SENSE HD Size 2\*

W1300004

CMOS sensor with optic fiber of 1.5 million of pixels (size 1) or 2.21 millions of pixels (size 2), theoretical resolution of 25lp/mm, actual resolution > 18lp/mm, 3.0 m USB cable.

with a sensor holder, 20 sensor sheaths, the ACTEON® Imaging Suite (AIS) software.

### U-SENSE



U-SENSE Size 1\*

W1300001

U-SENSE Size 2\*

W1300002

CMOS sensor with optic fiber of 1.5 million of pixels (size 1) or 2.21 millions of pixels (size 2), theoretical resolution of 25lp/mm, actual resolution > 14lp/mm, 3.0 m USB cable.

with a sensor holder, 20 sensor sheaths, the ACTEON® Imaging Suite (AIS) software.

\*please address to your ACTEON® contact the to check the availability of this product in your country

## Accessories

### ACTEON® Imaging Suite (AIS) software



ACTEON® Imaging Suite (AIS)  
USB stick

990263

Class IIb Medical device (IMQ) - CE0051 - Manufacturer: de Gotzen ACTEON® Group - Italy

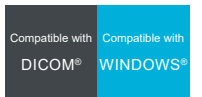

WINDOWS®	MINIMUM CONFIGURATION REQUIRED
Operating	Windows® 10 PRO 64bits
Processor	Intel® core i5 - 2 Cores 4 thread
RAM	8GB
Hard disk	250GB (SSD)
USB port	2 USB2.0 Hi-Speed ports
Graphic card	OPEN GL 2.1 or DirectX 9 or 11 Graphics device
USB Chipset	Intel® or NEC® / RENESAS®
Screen resolution	1600x1024

# INTRAORAL CAMERAS

.....

<b>C50</b>	<b>60</b>
<b>SOPROCARE®</b>	<b>62</b>
<b>SOPRO 617</b>	<b>64</b>
<b>Docking stations</b>	<b>66</b>
<b>Cameras connections</b>	<b>70</b>

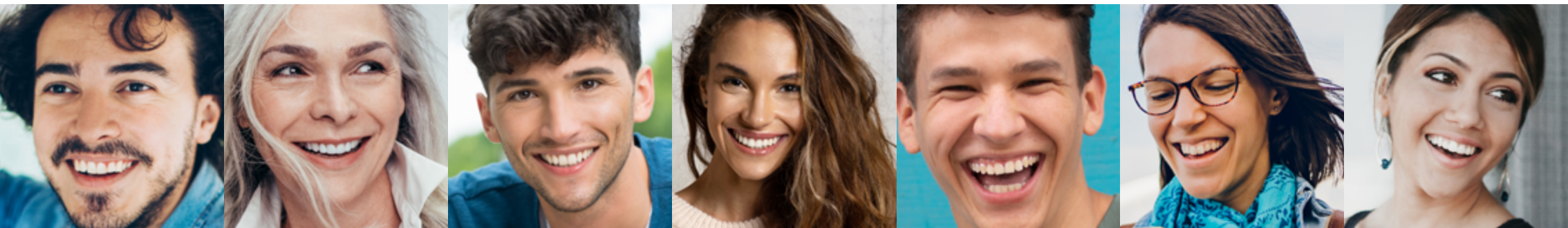

# C50 Daylight

The **C50 camera** is a powerful tool for pathology monitoring, post-treatment and follow up. It is a powerful communication tool, helping patients to understand their condition through clear, striking images.

It has become a must for before and after treatment comparisons, helping to boost productivity by increasing treatment acceptance rates.

## Remarkable clinical vision

**Full HD resolution**  
high resolution for superior image quality

**Autofocus**  
a clear, setting-free image for smooth navigation

**4 camera shots available**  
macrovision, single tooth, smile and portrait



Macrovision



Tooth



Smile



Portrait

Intraoral camera shots

Extraoral camera shots

## Remarkable operational freedom

**Plug & Play:** ready to use with pre-installed driver

**Customize settings:** a wide range of settings to suit your needs

**100% compatible:** Twain & Dicom

**Supplied with Acteon Imaging Suite:** all its features are packed into a clean and neat user interface that seamlessly integrates all your imaging devices & your PMS

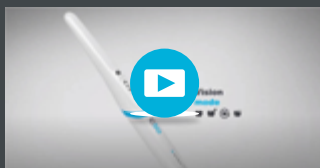

Compatible with DICOM®

Compatible with WINDOWS®



# C50 with Diagnostic-Aid option

4 cameras in 1

The **C50 camera with diagnostic-aid option** is the only camera on the market to cover so many pathologies, featuring 4 integrated vision modes for seamless navigation.

## Remarkable clinical vision

**Full HD resolution**  
high resolution for superior image quality

**Autofocus**  
a clear, setting-free image for smooth

**4 camera shots available**  
macrovision, single tooth, smile and portra

## Remarkable clinical versatility





**DAYLIGHT MODE**

Record of **natural colors** for a better interpretation of tooth shade, pathology identification and patient follow-up



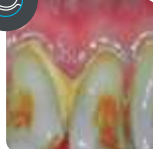

**PERIO MODE**

Enhancement of dental plaque and gingival inflammation thanks to chromatic amplification





**DAYLIGHT+ MODE**

High contrasts emphasizing anatomic fissures and details of the dentin structure/depth





**CARIO MODE**

Caries detection by fluorescence technique by LEDs

C50 with diag aid	S_C50_0001
C50 without diag aid	S_C50_0002

Class I medical device - CE - Manufacturer: Sopro ACTEON® Group - France

Computer requirements	Specs
<b>CPU</b>	Intel Core i5 4 core 2GHz Gen 8 or greater and Apple M1 or greater
<b>RAM</b>	8GB
<b>USB version</b>	3.0 or greater
<b>USB chipset</b>	Intel or Renesas
<b>Operating system</b>	from Windows® 10 PRO 64 bits or macOS Ventura

# soprocare

## Go beyond the visible

**With the push of a button, SOPROCARE® instantly and easily highlights**

- Caries
- Plaque
- Calculus
- Gingival inflammation



**PERIO Mode**

### SELECTIVE CHROMATIC AMPLIFICATION

3 needs, 3 modes

- PERIO mode: highlight plaque, calculus, and gingival inflammation.
- CARIO mode: caries are detected as red, surrounding tissue is displayed in black and white.
- DAYLIGHT mode: communicate more effectively with your patient and see details that are not visible with the naked eye.



**CARIO Mode**

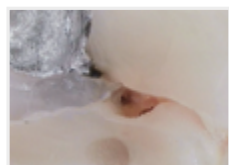

**DAYLIGHT Mode**

SOPROCARE® is an unparalleled communication tool in the dental practice!

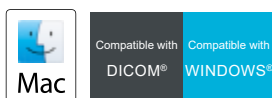

### SOPROCARE® handpiece

S\_950\_0008

with four SOPROTIPS, a handpiece holder, ACTEON® Imaging Suite (AIS) software and its licence. Needs to be used with a docking station.

Class I medical device - CE - Manufacturer: Sopro ACTEON® Group - France

## Accessories



SOPROCARE®  
+  
Mini Dock USB2

S\_950\_0008  
+  
S\_717\_1602



SOPROCARE®  
+  
Mini Dock U USB2<sup>(1)</sup>

S\_950\_0008  
+  
MINI DOCK  
U\_USB2

(1) Mini Dock U USB2 : Built-in docking station with USB2 output.

Class I medical devices - CE - Manufacturer: Sopro ACTEON® Group - France

WINDOWS®	MINIMUM CONFIGURATION REQUIRED
Operating	Windows® 10 PRO 64bits
Processor	Intel® core i5 - 2 Cores 4 thread
RAM	8GB
Hard disk	250GB (SSD)
USB port	2 USB2.0 Hi-Speed ports
Graphic card	OPEN GL 2.1 or DirectX 9 or 11 Graphics device
USB Chipset	Intel® or NEC® / RENESAS®
Screen resolution	1600x1024

MAC®	MINIMUM CONFIGURATION REQUIRED
Computer	MacBook® Pro 13" or iMac® 21.5"
Operating system	macOS Ventura
Processor	Intel® Core i5 or from Apple M1
RAM	8GB



# sopro617

## Look further, easily

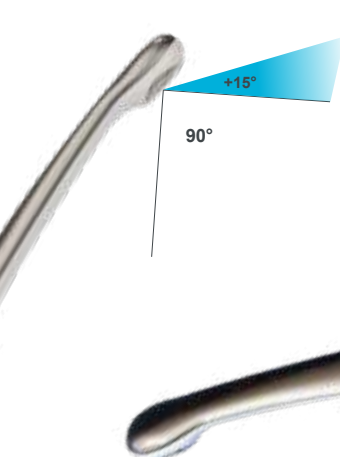

### Technology at your service

Provide a reliable clinical diagnosis thanks to a clear and high-quality dental image

### Comfort at your fingertips

Enhance your vision during examination with an optimized ergonomic



### Clinical performance at a glance

Improve patient experience and increase treatment acceptance with visual support

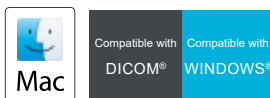

### SOPRO® 617 handpiece

S\_617\_0031

with a SOPRO® 617 handpiece holder, ACTEON® Imaging Suite (AIS) software and its licence.  
Needs to be used with a docking station

Class I medical device - CE - Manufacturer: Sopro ACTEON® Group - France

## Accessories



SOPRO® 617  
+  
Mini Dock USB2

S\_617\_0031  
+  
S\_717\_1602



SOPRO® 617  
+  
Mini Dock U USB2<sup>(1)</sup>

S\_617\_0031  
+  
MINI DOCK  
U\_USB2

(1) Mini Dock U USB2 : Built-in docking station with USB2 output.

Class I medical devices - CE - Manufacturer: Sopro ACTEON® Group - France

WINDOWS®	MINIMUM CONFIGURATION REQUIRED
Operating	Windows® 10 PRO 64bits
Processor	Intel® core i5 - 2 Cores 4 thread
RAM	8GB
Hard disk	250GB (SSD)
USB port	2 USB2.0 Hi-Speed ports
Graphic card	OPEN GL 2.1 or DirectX 9 or 11 Graphics device
USB Chipset	Intel® or NEC® / RENESAS®
Screen resolution	1600x1024

MAC®	MINIMUM CONFIGURATION REQUIRED
Computer	MacBook® Pro 13" or iMac® 21.5"
Operating system	macOS Ventura
Processor	Intel® Core i5 or from Apple M1
RAM	8GB

# Docking stations



**Mini Dock USB2**  
docking station USB2.0 Including one 2.5 meters linking cable and one 0.8 meter repeater cable

S\_717\_1602



**Mini Dock U USB2**  
built-in docking station with USB2 output  
Please select the accessories for this module on next page

MINI DOCK U\_USB2

Class I medical devices - CE - Manufacturer: Sopro ACTEON® Group - France

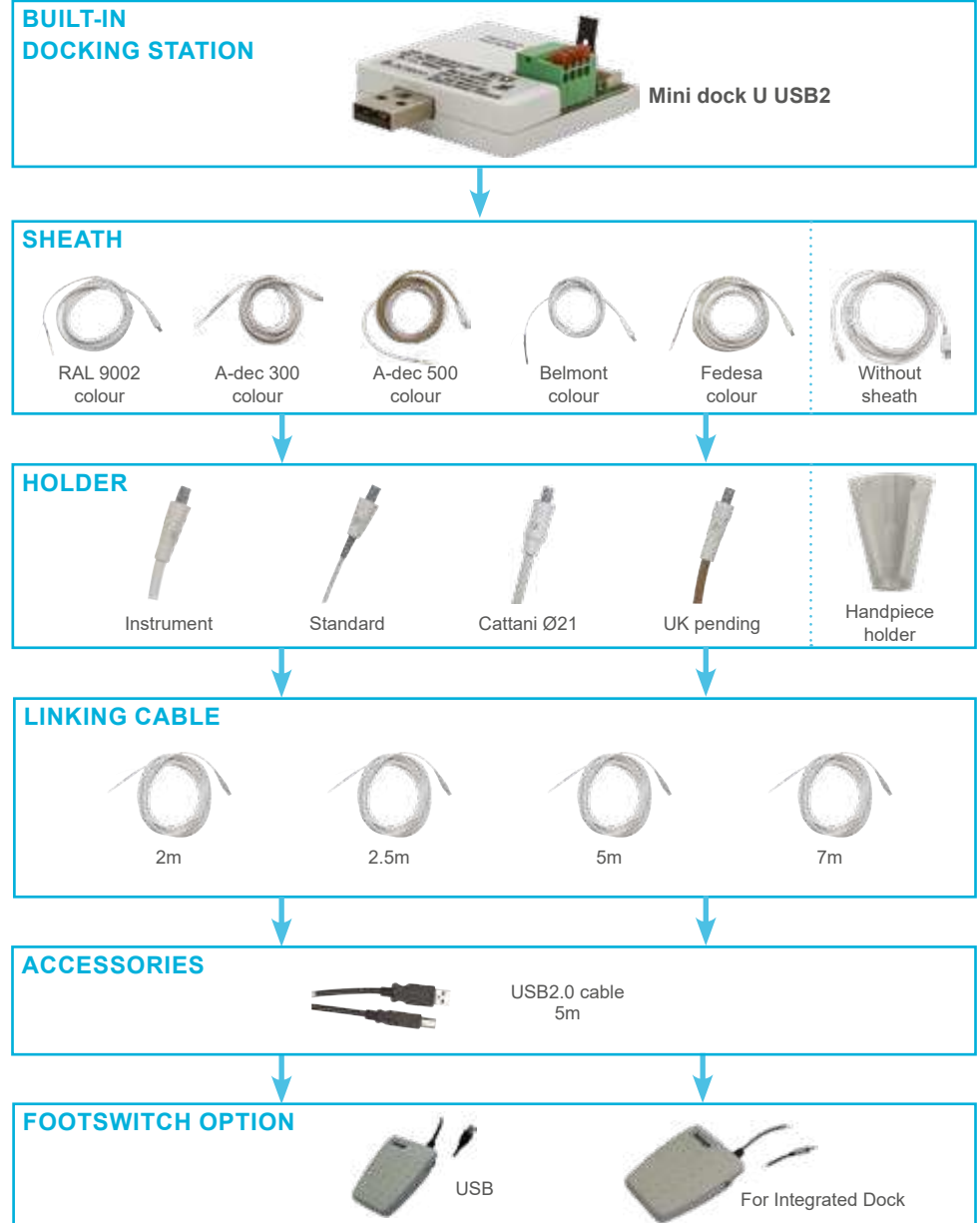
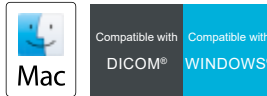

## Accessories

### ACTEON® Imaging Suite (AIS) software



**ACTEON® Imaging Suite<sup>(2)</sup> (AIS)**  
USB stick

990263

Class IIb Medical device (IMQ) - CE0051 - Manufacturer: de Gotzen ACTEON® Group - Italy



**Footswitch for image memory**

009002



**USB2 footswitch for image memory**

009009



**Sheaths for SOPROLIFE®,  
SOPROCARE® or SOPRO® 717 First**  
500 pieces in a single pasteboard

403017

**Sheaths for SOPRO® 617**  
500 pieces in a single pasteboard

403023

**Sheaths for SOPRO® 595**  
500 pieces in a single pasteboard

403001



**Handpiece holder for SOPROLIFE®,  
SOPROCARE®, Sopro® 717 First,  
SOPRO® 617 and SOPRO® 595**  
only for unsheathed linking cables

926063



**SOPROTIPS for SOPROLIFE® and  
SOPROCARE®**  
protection tip against light  
sterilization by autoclave (set of 4 pieces)

990135

## Cables



**Linking cable 2.5m**  
with connector on both sides  
SOPROLIFE®/Sopro® 717/Sopro® 617

922050

**Linking cable 5m**  
with connector on both sides  
SOPROLIFE®/Sopro® 717/Sopro® 617

922051

**Linking cable 7m**  
with connector on both sides  
SOPROLIFE®/Sopro® 717/Sopro® 617

922120



**Video cable**  
with RCA/RCA connector  
length: 1.5m

002003



**Video cable**  
with YC/YC connector  
length: 1.5m

002004



**S-video cable**  
with YC/YC connector  
length: 5m

700012



**USB2.0 cable**  
A/B type.  
length: 2m

002081



**USB2.0 cable**  
A/B type.  
length: 5m

002091

**Mini USB2.0 cable**  
only for Dock U-USB2  
length: 5m

002148

**USB2.0 active repeater cable (Booster)**  
length: 5m

700381

# Windows connection

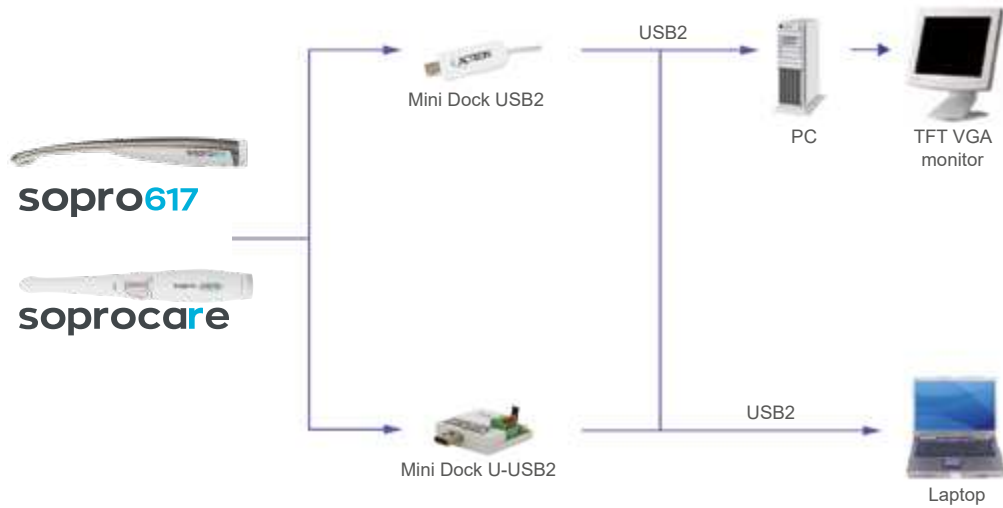
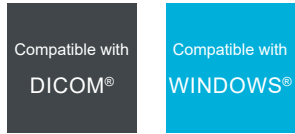

# Mac connection

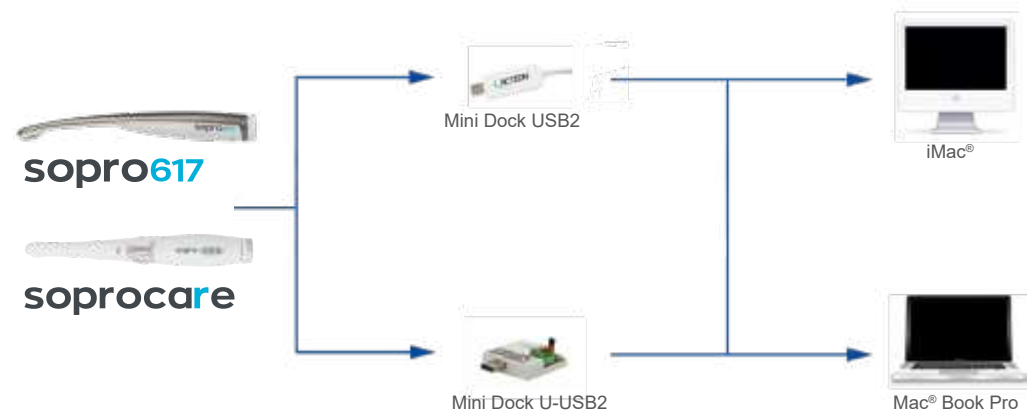

---

# ACTEON<sup>®</sup> EQUIPMENT

<b>SURGERY</b>	<b>74</b>
<b>ULTRASONICS</b>	<b>96</b>
<b>POLISHERS</b>	<b>126</b>
<b>CURING LIGHT</b>	<b>136</b>
<b>MISCELLANEOUS</b>	<b>146</b>

# SURGERY

.....

<b>Compatibility references</b>	<b>76</b>
<b>PIEZOTOME® Cube</b>	<b>78</b>
<b>IMPLANT CENTER 2</b>	<b>80</b>
<b>Surgery tips</b>	<b>84</b>
<b>Implant motors</b>	<b>92</b>
<b>SERVOTOME®</b>	<b>94</b>



# Warning

Some accessories adapted to **PIEZOTOME® 2**, **PIEZOTOME® Solo**, **PIEZOTOME® Cube** and **IMPLANTCENTER™ 2** are not compatible with the first generation **PIEZOTOME®** and **IMPLANTCENTER™**, and vice-versa

- References compatible with 1<sup>st</sup> generation devices are indicated by a blue square : ■
- References compatible with 2<sup>nd</sup> and 3<sup>rd</sup> generation devices are indicated by a grey square : ■

## 3<sup>RD</sup> GENERATION

piezotome  
cube



## 2<sup>ND</sup> GENERATION



piezotome 2

PIEZOTOME  
SOLO

implant center 2

## 1<sup>ST</sup> GENERATION



**PIEZOTOME**  
Piezo • Ultrasonic • Surgery • Unit

**IMPLANTCENTER**  
Piezo • Ultrasonic • Surgery & Implantology Unit



# piezotome cube

## Powerfully responsive, minimally invasive



- Socket preservation<sup>(1)</sup>
- Safe for soft tissues
- Recommended for immediate implant placement
- No force needed
- 50% less pain & swelling<sup>(2)</sup>
- 98% less analgesics intake<sup>(3)</sup>

**Piezotome® Cube<sup>(1)</sup> with Essential II kit**

**F50100** ■

with a multifunction footswitch, a CUBE LED handpiece, 1 handpiece holder, an Essential II kit (BS1S II, BS4 II, SL1 II, SL2 II, SL3 II and LC2 II), a Piezotome® autoclave dynamometric wrench, 1 bracket, 2 sterilizable irrigation lines<sup>(2)</sup>, 5 clips and 15 perforators.

(1) Kleiber J. Immediate extraction placement and loading in the aesthetic zone. *Implant Dentistry Today*. 2013 Jan;7:13

(2) Shanghai Kou Qiang Yi Xue. Comparative study of complications among routine method, high speed turbine handpiece and piezosurgery device after extraction of impacted wisdom teeth. *Shanghai Journal of Stomatology*. 2012 Apr;21(2):208-10.

(3) Troedhan A, Kurrek A, Wainwright M. Ultrasonic Piezotome surgery: it is a benefit for our patients and does it extend surgery time? A retrospective comparative study on the removal of 100 impacted mandibular 3rd molars. *Open Journal of Stomatology*. 2011;1:179-184

## Accessories



**CUBE LED handpiece**  
Compatible with 2<sup>nd</sup> generation piezo tips

**F12816** ■



**Multifunction footswitch**

**F50109**



**Handpiece holder**

**F50133**



**Piezotome® autoclavable  
dynamometric wrench**

**F50150**



**Irrigation line clips x10**

**F50116**



**Bracket for Piezotome® Cube**

**F50129**



**Light ring**  
CUBE LED handpiece

**F12828**



Piezotome® Cube  
& Tips catalog



Around Piezotome® Cube video

(1) Intraoral surgery ultrasonic control console

Class IIa medical devices (GMED) - CE 0459 - Manufacturer: SATELEC® ACTEON® Group - France

(2) Irrigation set - Class Is medical device (GMED) - CE 0459 - Manufacturer: SATELEC® ACTEON® Group - France



# implant center 2



## Functions

- I-Surge™: Rotative Surgery Motor
- Piezotome®: Piezo electric surgery
- Newtron®: Conventional ultrasound treatment (Scaling, perio, endo, apical surgery,...)

## ImplantCenter™ 2<sup>(1)</sup>

**F27200** ■

with a LED motor, a LED motor cord, a progressive footswitch, 2 brackets, 2 handpiece holders, 2 autoclavable irrigation lines<sup>(2)</sup> and 30 perforators.

This reference does not include the Piezotome® 2 handpiece and tips.

(1) Ultrasonic control console for conventional dentistry and intraoral dentistry and motor control console for dental implantology  
Class IIa medical devices (GMED) - CE 0459 - Manufacturer: SATELEC® ACTEON® Group - France

(2) Irrigation set - Class Is medical device (GMED) - CE 0459 - Manufacturer: SATELEC® ACTEON® Group - France

This system is designed exclusively for dental surgery and implant procedures performed at a dental practice. The use of the device in a hospital or clinic operating theatre constitutes a use that is excluded from the device's regulatory framework. ACTEON® offers a medical range suitable for use in the operating room. Do not hesitate to consult us for more information.

## Accessories

	ImplantCenter™ progressive footswitch	F27120 ■
	ImplantCenter™ 2 progressive footswitch	F27170 ■
	Support for motor or handpiece	F02463 ■ ■
	Bracket	E27113 ■ ■
	I-Surge™ LED light micro-motor <sup>(1)</sup>	F27210 ■
	Disconnectable I-Surge™ LED micro-motor cord	F27211 ■
	20:1 Bien-Air* LED contra-angle <sup>(2)</sup> green ring	F36132 ■
	I-Surge™ micro-motor <sup>(1)</sup>	F27123 ■ ■
	Disconnectable I-Surge™ micro-motor cord	F27124 ■ ■
	Disconnectable I-Surge™ micro-motor cord + micro-motor	F34450 ■ ■
	Mont Blanc 20:1 Anthogyr* contra-angle <sup>(3)</sup> green ring (non LED)	F36140 ■ ■
	Atomizer dropper for Mont Blanc 20:1 Anthogyr* contra-angle	F36141 ■ ■

\* Bien-Air and Anthogyr are registered trademarks

(1) Class IIa medical devices (GMED) - CE 0459 - Manufacturer: SATELEC® ACTEON® Group - France

(2) Class IIa medical device - CE 0120 - Manufacturer: Bien Air - Distributor: SATELEC® ACTEON® Group - France

(3) Class IIa medical device (GMED) - CE 0459 - Manufacturer: Anthogyr - Distributor: SATELEC® ACTEON® Group - France

## Accessories

The handpieces are equipped with keyway systems to prevent a Piezotome® tip (Bone Surgery, Sinus Lift, Extraction, etc.) from being screwed onto a Newtron® handpiece or a classic tip (scaling, periodontics, endodontics, etc.) from being screwed onto a Piezotome® handpiece.

	<b>Piezotome® handpiece<sup>(1)</sup> + cord</b>	<b>F57321</b> ■
	<b>Piezotome® LED handpiece<sup>(1)</sup> + cord</b>	<b>F12815</b> ■
	<b>Newtron® handpiece<sup>(2)</sup></b>	<b>F12281</b> ■ ■
	<b>Newtron® LED handpiece<sup>(2)</sup></b>	<b>F12609</b> ■
	<b>Newtron® cord Piezotome</b>	<b>F57305</b> ■
	<b>Newtron® cord Piezotome 2</b>	<b>F12850</b> ■
	<b>Newtron® LED cord Piezotome 2</b>	<b>F12830</b> ■
	<b>Light ring</b>	<b>F12821</b> ■
	<b>Piezotome® autoclavable dynamometric wrench</b>	<b>F50150</b> ■ ■
	<b>Bracket</b>	<b>E27113</b> ■ ■

(1) Intraoral surgery ultrasonic handpieces - Class IIa medical device (GMED) - CE 0459 - Manufacturer: SATELEC® ACTEON® Group - France  
 (2) Dental ultrasonic handpieces - Class IIa medical device (GMED) - CE 0459 - Manufacturer: SATELEC® ACTEON® Group - France



**ImplantCenter™ cart**  
 dimensions (DxWxH) : 66 x 54 x 79cm  
 3 glass trays: 60 x 50cm  
 connections for water and electricity

**F27125** ■ ■



**Piezotome® 2 pack<sup>(4)</sup>** (without tip)  
 with an autoclavable Piezotome® 2  
 handpiece with cord and a Piezotome®  
 wrench

**F87523** ■



**Sterilization box**

**F27156** ■ ■



**Universal irrigation lines<sup>(1)</sup> Sterile** x10  
 single-use with integrated cassette and  
 flow control system

**F59905** ■ ■



**Autoclavable irrigation line<sup>(2)</sup> x1**  
 + 10 sterile perforators<sup>(3)</sup>

**F57374** ■ ■



**Autoclavable irrigation line<sup>(2)</sup> x1**

**E59920** ■ ■



**Disposable sterile perforators<sup>(3)</sup> x10**

**F57372** ■ ■



**Irrigation line clip**

**E57353** ■ ■



**Piezotome® 2 progressive footswitch**

**F57404** ■



**Piezotome® Solo and  
 Piezotome® Solo LED footswitch**

**F57504** ■

(1) Irrigation set - Irrigation line - Class Is medical device (GMED) - CE 0459 - Manufacturer: SATELEC® ACTEON® Group - France  
 (2) Class I medical device - CE - Manufacturer: SATELEC® ACTEON® Group - France  
 (3) Class Is medical devices (GMED) - CE 0459 - Manufacturer: PROMEPLA - Distributor: SATELEC® ACTEON® Group - France  
 (4) Class IIa medical device (GMED) - CE 0459 - Manufacturer: SATELEC® ACTEON® Group - France

## Bone surgery



### Bone Surgery pack

with an autoclavable Piezotome® handpiece with cord, a Bone Surgery II kit and a Piezotome® autoclave dynamometric wrench

**F87500** ■



### Bone Surgery II kit

with BS1S II, BS2L II, BS2R II, BS4 II, BS5 II, BS6 II tips, an autoclavable metal support, an autoclavable universal wrench

**F87509** ■

### Bone Surgery II kit support

**X88456** ■

### Saws



**BS2L II - Left-angled**

**F87502** ■

**BS2R II - Right-angled**

**F87503** ■

**BS1S II "Slim" - Depth of cut 9mm**

**F87525** ■



**BS1L II "Long" - Depth of cut 15mm with universal wrench**

**F87527** ■

**BS1RD II - Rounded saw, 280° of active surface**

**F87557** ■

### Scrapers



**BS4 II**

**F87504** ■

**BS5 II**

**F87505** ■

**BS6 II**

**F87506** ■



Learn more



## Sinus lift



### Sinus Lift pack

with a sterilization box, an autoclavable Piezotome® handpiece with cord, a Sinus Lift II kit and a Piezotome® autoclave dynamometric wrench

**F87510** ■



### Sinus Lift II kit

with SL1 II, SL2 II, SL3 II, SL4 II, SL5 II tips, an autoclavable metal support, an autoclavable universal wrench

**F87519** ■

### Sinus Lift II kit support

**X88457** ■



**SL1 II**

**F87511** ■

**SL2 II**

**F87512** ■



**SL3 II**

**F87513** ■

**SL4 II**

**F87514** ■

**SL5 II**

**F87515** ■



Learn more



# Intralift



**Intralift™ pack**  
with a sterilization box, an autoclavable Piezotome® handpiece with cord, an Intralift II kit, an autoclavable universal wrench

**F87530** ■



**Intralift™ II kit**  
with TKW1 II, TKW2 II, TKW3 II, TKW4 II, TKW5 II tips, an autoclavable metal support, an autoclavable universal wrench

**F87536** ■

**Intralift™ II kit support**

**X88458** ■

**TKW1 II** - Conical tip Ø1.35mm (pilot drilling)

**F87531** ■

**TKW2 II** - Cylindrical tip Ø2.1mm (preliminary drilling)

**F87532** ■

**TKW3 II** - Cylindrical tip Ø2.35mm (preliminary drilling)

**F87533** ■

**TKW4 II** - Cylindrical tip Ø2.8mm (secondary drilling)

**F87534** ■

**TKW5 II** - Non cutting "trumpet" tip (sinus membrane elevation)

**F87535** ■



Learn more



# Extraction



**Extraction pack**  
with a sterilization box, an autoclavable Piezotome® handpiece with cord, an Extraction II kit and a Piezotome® autoclavable dynamometric wrench

**F87540** ■



**Extraction II kit**  
with LC1 II, LC2 II (x2), LC2L II, LC2R II, Ninja® II tips, an autoclavable metal support, an autoclavable universal wrench

**F87546** ■

**Extraction II kit support**

**X88459** ■

**LC1 II**

**F87507** ■

**LC2 II**

**F87542** ■

**LC2L II**

**F87543** ■

**LC2R II**

**F87544** ■

**Ninja® II**

**F87545** ■



Learn more

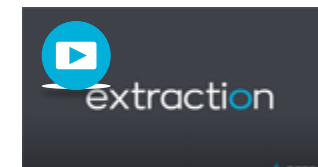

## Crown extension



### Crown Extension pack

with a sterilization box, an autoclavable Piezotome® handpiece with cord, a Crown Extension II kit and a Piezotome® autoclavable dynamometric wrench

**F87550** ■



### Crown Extension II kit

with BS6 II, CE1 II, CE2 II, CE3 II tips, an autoclavable metal support, an autoclavable universal wrench

**F87554** ■



**CE1** - Diamond-coated spherical tip  
Ø1.75mm

**F87551** ■



**CE2** - Diamond-coated spherical tip  
Ø1.20mm

**F87552** ■



**CE3** - Diamond-coated straight tip on 5mm  
(laser mark placed at 3mm: biologic width)

**F87553** ■



**BS6 II**

**F87506** ■



Learn more



## Crest splitting



### Crest Splitting pack

with a sterilization box, an autoclavable Piezotome® LED handpiece with cord, a Crest Splitting II kit and a Piezotome® autoclavable dynamometric wrench

**F87560** ■



### Crest Splitting II kit

with CS1 II, CS2 II, CS3 II, CS4 II, CS5 II, CS6 II tips, an autoclavable metal support, an autoclavable universal wrench

**F87567** ■

### Crest Splitting II kit support

**X88464** ■

### CS1 II

**F87561** ■



### CS2 II

**F87562** ■

### CS3 II

**F87563** ■

### CS4 II

**F87564** ■



### CS5 II

**F87565** ■

### CS6 II

**F87566** ■



Learn more



## Piezocision™

### Piezocision™ pack

with a sterilization box, an autoclavable Piezotome® LED handpiece with cord, a Piezocision™ II kit and an autoclavable universal wrench

**F87570** ■

### Piezocision™ II kit support

**X88472** ■

### PZ1 II - Anterior corticotomies

**F87571** ■

### PZ3 II - Anterior corticotomies for root proximity concerns

**F87574** ■



Learn more

## Other packs & kits



### Essential pack

with a sterilization box, an autoclavable Piezotome® 2 handpiece with cord and an Essential II Kit and a Piezotome® autoclavable dynamometric wrench

**F87529** ■



### Essential II kit

with BS1S II, BS4 II, SL1 II, SL2 II, SL3 II, LC2 II tips, an autoclavable metal support, an autoclavable universal wrench

**F87528** ■



### Universal II kit

with BS6 II, LC1 II, LC2 II, CE1 II, CE3 II, PZ1 II tips, an autoclavable metal support, an autoclavable universal wrench

**F87539** ■



### Newtron® perio pack

with a sterilization box, an autoclavable Newtron® handpiece, an autoclavable Newtron® cord, a Newtron® Perio kit and a Piezotome® autoclavable dynamometric wrench

**F87520** ■

### Newtron® pack (without tip)

with a sterilization box, an autoclavable Newtron® LED handpiece, an autoclavable LED cord and a Piezotome® autoclavable dynamometric wrench

**F87524** ■



### Newtron® Implant Protect Kit

with IP1, IP2L, IP2R, IP3L and IP3R tips, an autoclavable metal support, an autoclavable universal wrench

**F02120** ■ ■



### Newtron® kit support

**X88451** ■ ■

### Important

Newtron® kits are compatible with the Newtron® and Newtron® LED handpieces

## Accessories

### I-Surge™



**Mont Blanc 20:1 Anthogyr\***  
contra-angle<sup>(4)</sup> green ring (non LED)

**F36140**



**Atomizer dropper**  
for Mont Blanc 20:1 Anthogyr\*  
contra-angle

**F36141**



**Universal irrigation lines<sup>(1)</sup> Sterile x10**  
single-use with integrated cassette and  
flow control system

**F59905**



**Autoclavable irrigation line<sup>(2)</sup> x1**  
+ 10 sterile perforators<sup>(3)</sup>

**F57374**



**Autoclavable irrigation line<sup>(2)</sup> x1**

**E59920**



**Disposable sterile perforators<sup>(3)</sup> x10**

**F57372**



**Irrigation line clip**

**E57353**



**I-Surge™ power supply**

**F28955**



**Micromotor holder**  
white silicone

**F02463**

\* Anthogyr is registered trademarks

### I-Surge™+ & HT-Implant



**Irrigation line<sup>(2)</sup> x10**

**F28750**

(1) Irrigation set - Irrigation line - Class Is medical device (GMED) - CE 0459 - Manufacturer: SATELEC® ACTEON® Group - France

(2) Class I medical device - CE - Manufacturer: SATELEC® ACTEON® Group - France

(3) Class Is medical devices (GMED) - CE 0459 - Manufacturer: PROMEPLA - Distributor: SATELEC® ACTEON® Group - France

(4) Class IIa medical device (GMED) - CE 0459 - Manufacturer: Anthogyr - Distributor: SATELEC® ACTEON® Group - France



# servotome



High frequency electrosurge or orthodontics, periodontics and other oral surgery

## Servotome® II

**F57210**

with a single footswitch, a box with 10 electrodes, a conductive bracelet.

Intraoral electrosurgery control console - Class IIb medical device (GMED) - CE 0459 - Manufacturer: SATELEC® ACTEON® Group - France

## Accessories



**Conductive bracelet**

**F57226**



**Electrode holder<sup>(1)</sup>**

**F00476**



**Electrode holder cord (2m)**

**F00475**



**Servotome® II footswitch**

**F00059**

(1) Class IIb medical device (GMED) - CE 0459 - Manufacturer: SATELEC® ACTEON® Group - France

## Electrodes



**10 electrodes kit**

**F10440**

**10 electrodes + 1 electrode holder kit**

**F10472**



**I 22 S**

**F10421**



**I 22 CA**

**F10422**



**TR 22L**

**F10424**



**TR 22 R**

**F10425**



**TR 22 T**

**F10427**



**FC 25 B**

**F10428**



**FC 32 B**

**F10429**



**FC 10 N**

**F10430**



**I 40 S**

**F10431**



**I 40 CA**

**F10432**

Class IIb medical device (GMED) - CE 0459 - Manufacturer: SATELEC® ACTEON® Group - France



# ULTRASONICS

.....

<b>NEWTRON® Range</b>	<b>98</b>
<b>Tips</b>	<b>104</b>
<b>Tip kits</b>	<b>112</b>
<b>Wrenches</b>	<b>115</b>
<b>NEWTRON® Range IV</b>	<b>116</b>
<b>NEWTRON® Range III</b>	<b>118</b>
<b>NEWTRON® Range II</b>	<b>120</b>
<b>NEWTRON® Range I</b>	<b>122</b>
<b>Overview of Irrigation lines</b>	<b>124</b>



# Everyday, for every clinical situation

### PRECISION

Precise treatments thanks to the controlled linear vibrations



**newtron**  
p5XS

### PRESERVATION

Tissue preservation with the automatic and continuous frequency adjustment



**newtron**  
p5

### COMFORT

Comfort for the patient and practitioner thanks to the real time power adjustment



**newtron**  
booster



Newtron range video

## A large range of tips meeting all the clinical needs

The widest range on the market with **80 different tips**; with exclusive designs, alloys and coatings for clinical versatility.  
**Exclusive tips in Pure Titanium for implant cleaning.**

### PERIODONTICS



### IMPLANT CARE



### ENDODONTICS



### SURGICAL ENDODONTICS



### PROPHYLAXIS



### CONSERVATIVE AND RESTORATIVE DENTISTRY



Newtron® range & Tips catalog



Scaling TipCard  
Tip wear guide for scaling tips



Perio TipCard  
Tip wear guide for periodontal tips

# newtron p5XS



## Newtron® P5XS B.LED

F62100

with a non-disconnectable footswitch, a power supply, a Newtron® SLIM B.LED handpiece cord, a Newtron® SLIM B.LED handpiece with a blue ring, a Newtron® SLIM B.LED white LED ring, a F.L.A.G™ for B.LED (5x 1.5ml) dental plaque discloser, an autoclavable universal wrench, 3 tips (N°1, N°1S, N°H3) and a 300ml tank

Dental ultrasonic control console - Class IIa medical device (GMED) - CE 0459 - Manufacturer: SATELEC® ACTEON® Group - France



### Important

Handpieces compatible with all ACTEON® Equipment Dental Tips (with color coded ring: Color Coding System™)

# newtron p5



## Newtron® P5 B.LED

F61101

with a non-disconnectable footswitch, a power supply, a Newtron® SLIM B.LED handpiece cord, a Newtron® SLIM B.LED handpiece with a blue ring, a Newtron® SLIM B.LED white LED ring, a F.L.A.G™ for B.LED (5x 1.5ml) dental plaque discloser, a N°1 tip and an autoclavable universal wrench

Dental ultrasonic control console - Class IIa medical device (GMED) - CE 0459 - Manufacturer: SATELEC® ACTEON® Group - France



### Important

Handpieces compatible with all ACTEON® Equipment Dental Tips (with color coded ring: Color Coding System™)

# newtron booster



## Newtron® Booster

F60203

with a Newtron® non-disconnectable footswitch, a power supply, a Newtron® handpiece cord, a Newtron® handpiece, a N°1 tip and an autoclavable universal wrench

Dental ultrasonic control console - Class IIa medical device (GMED) - CE 0459 - Manufacturer: SATELEC® ACTEON® Group - France



### Important

Handpieces compatible with all ACTEON® Equipment Dental Tips (with color coded ring: Color Coding System™)





Learn more



## Tips

### scaling

	<b>N°1 - Universal</b>	<b>F00246</b>
	<b>N°2 - High power</b>	<b>F00247</b>
	<b>N°3 - Removing stains</b>	<b>F00248</b>
	<b>10P - Supra and sub-gingival &lt; 3mm</b>	<b>F00253</b>
	<b>10X - Interproximal</b>	<b>F00359</b>
	<b>10Z - Subgingival</b>	<b>F00254</b>
	<b>N°1S - Supra and sub-gingival</b>	<b>F00245</b>







### periofine

	<b>PFU - Universal</b>	<b>F02170</b>
	<b>PFL - Left-angled</b>	<b>F02171</b>
	<b>PFR - Right-angled</b>	<b>F02172</b>

## Tips



### periodontics

#### Curettes & debridement

	<b>H1 - Anterior teeth, diamond-coated</b>	<b>F00366</b>
	<b>H2L - Premolars &amp; molars, left-angled</b>	<b>F00367</b>
	<b>H2R - Premolars &amp; molars, right-angled</b>	<b>F00368</b>
	<b>H3 - Anterior teeth, curette</b>	<b>F00369</b>
	<b>H4L - Premolars &amp; molars, left-angled</b>	<b>F00114</b>
	<b>H4R - Premolars &amp; molars, right-angled</b>	<b>F00115</b>

### implantprotect pure titanium

#### Peri-implantitis treatment

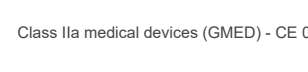
	<b>IP1 - Implant abutments and wide threads</b>	<b>F02121</b>
	<b>IP2L - Medium implant threads, left-angled</b>	<b>F02122</b>
	<b>IP2R - Medium implant threads, right-angled</b>	<b>F02123</b>
	<b>IP3L - Narrow implant threads, left-angled</b>	<b>F02124</b>
	<b>IP3R - Narrow implant threads, right-angled</b>	<b>F02125</b>







Learn more



## Tips

perio  
maintenance BDR

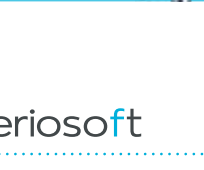

### Periodontal maintenance

	<b>TK1-1S</b> - Short probe	<b>F01001</b>
	<b>TK1-1L</b> - Long probe	<b>F01004</b>
	<b>TK2-1L</b> - Premolars & molars, left-angled	<b>F02162</b>
	<b>TK2-1R</b> - Premolars & molars, right-angled	<b>F02161</b>

## periosoft



### implant maintenance



	<b>PH1</b> - Anterior teeth (x4)	<b>F00702</b>
	<b>PH2L</b> - Premolars & molars, left-angled (x4)	<b>F00705</b>
	<b>PH2L</b> - Premolars & molars, right-angled (x4)	<b>F00706</b>

## perio precision



	<b>P2L</b> - Narrow pockets debridement, left-angled	<b>F00090</b>
	<b>P2R</b> - Narrow pockets debridement, right-angled	<b>F00091</b>

## Tips

endodontics

### Endodontics - Irrigation





	<b>K10-21</b> - Ø 0.1/length 21mm (x4)	<b>F43710</b>
	<b>K10-25</b> - Ø 0.1/length 25mm (x4)	<b>F43712</b>
	<b>K15-21</b> - Ø 0.15/length 21mm (x4)	<b>F43715</b>
	<b>K15-25</b> - Ø 0.15/length 25mm (x4)	<b>F43717</b>
	<b>K25-21</b> - Ø 0.25/length 21mm (x4)	<b>F43725</b>
	<b>K25-25</b> - Ø 0.25/length 25mm (x4)	<b>F43727</b>
	<b>K30-21</b> - Ø 0.30/length 21mm (x4)	<b>F43730</b>
	<b>K30-25</b> - Ø 0.30/length 25mm (x4)	<b>F43732</b>

## irrisafe

### Passive Ultrasonic Irrigation

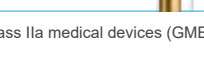

	<b>IRR 20-21</b> - Ø 0.2/length 21mm (x4)	<b>F43807</b>
	<b>IRR 20-25</b> - Ø 0.2/length 25mm (x4)	<b>F43808</b>
	<b>IRR 25-21</b> - Ø 0.25/length 21mm (x4)	<b>F43805</b>
	<b>IRR 25-25</b> - Ø 0.25/length 25mm (x4)	<b>F43806</b>





Learn more



## Tips



### endosurgery

#### Apical surgery

	<b>P14D</b> - Universal	<b>F00106</b>
	<b>S12-70D</b> - 70° Universal	<b>F00118</b>
	<b>P15LD</b> - Left-angled	<b>F00107</b>
	<b>P15RD</b> - Right-angled	<b>F00108</b>

### endodontics

#### Retreatment





	<b>ET40</b> - Length 40mm	<b>F88012</b>
	<b>ET40D</b> - Length 40mm, diamond-coated	<b>F88014</b>
	<b>ET20D</b> - Length 20mm, diamond-coated	<b>F88013</b>
	<b>SO4</b> - Gutta Percha condenser	<b>F88009</b>



## Tips







### endosuccess apical surgery



	<b>AS3D</b> - Universal, Length 3mm	<b>F00065</b>
	<b>AS6D</b> - Length 6mm	<b>F00079</b>
	<b>AS9D</b> - Length 9mm	<b>F00067</b>
	<b>ASLD</b> - Length 3mm, left-angled (premolars)	<b>F00080</b>
	<b>ASRD</b> - Length 3mm, right-angled (premolars)	<b>F00081</b>

### endosuccess retreatment

#### Retreatment

	<b>ET18D</b> - Cavity access finishing	<b>F88017</b>
	<b>ETBD</b> - Exploration	<b>F88020</b>
	<b>ET25S</b> - Short Ti-Nb tip	<b>F88021</b>
	<b>ET25</b> - Ti-Nb tip	<b>F88018</b>
	<b>ET25L</b> - Long Ti-Nb tip	<b>F88022</b>
	<b>ET20</b> - Universal	<b>F88011</b>
	<b>ETPR</b> - Loosening	<b>F88019</b>





Learn more



## Tips

### endosuccess canal access prep

**CAP1** - Cavity preparation **F88181**

**CAP2** - Canal localization **F88182**

**CAP3** - Canal opening **F88183**



### perfect margin rounded

#### Prosthetic finishing (rounded)

**PM1** - Preparation of the dentin **F02250**

**PM2** - Preparation/finishing **F02251**

**PM3** - Finishing **F02252**

**PM4** - Corono-radicular preparation, conical, diamond-coated 46µm **F02253**



## Tips

### Prosthesis

**C20** - Inlay/onlay condensation **F00113**

**Piezocem caps x10** **F00397**

**5AE** - Loosening with spray **F00249**



Class IIa medical devices (GMED) - CE 0459 - Manufacturer: SATELEC® ACTEON® Group - France





## Tip kits



### Scaling kit

with an autoclavable plastic box, N°1, N°1S, N°10X, H3 tips, four autoclavable dynamometric Newtron® wrenches

F00934



### Hygiene kit

with an autoclavable plastic box, N°1, N°1S, 10Z, TK1-1S tips, four autoclavable dynamometric Newtron® wrenches

F00935



### Perio kit

with an autoclavable plastic box, N°1S, H3, H4L, H4R tips, four autoclavable dynamometric Newtron® wrenches

F00936



### PerioPrecision kit

with an autoclavable plastic box, P2L, P2R, TK1-1S tips and three autoclavable dynamometric Newtron® wrenches

F00939



### Perio Maintenance kit (BDR)

with an autoclavable plastic box, TK1-1S, TK1-1L, TK2-1L, TK2-1R tips, four autoclavable dynamometric Newtron® wrenches

F00937



## Tip kits



### Implant Protect kit

with IP1, IP2L, IP2R, IP3L and IP3R tips, an autoclavable metal support and an autoclavable universal wrench

F02120



### Endo One kit

with CAP1, CAP2, CAP3, ET25, ETPR tips, 1 blister of 4 IrriSafe™ 25-21mm tips, an autoclavable metal support and an autoclavable universal wrench

F00732



### Endo Success™ Retreatment kit

with ET18D, ET20, ET25, ET25S, ETBD, ETPR tips, an autoclavable metal support and an autoclavable universal wrench

F00737



### Perfect Margin® Rounded kit

with PM1, PM2, PM3, PM4 tips, an autoclavable metal support and an autoclavable universal wrench

F00738



Learn more



Learn more

## Tip kits



**Endo Success™ Canal Access Prep kit**  
with CAP1, CAP2, CAP3 tips,  
an autoclavable metal support and  
an autoclavable universal wrench

**F88180**

**endosuccess**  
canal access prep



**Endo Success™ Apical Surgery kit**  
with AS3D, AS6D, AS9D, ASLD, ASRD  
tips, an autoclavable metal support and  
an autoclavable universal wrench

**F00069**

**endosuccess**  
apical surgery

## Boxes & Supports



**Autoclavable plastic box**  
with 4 autoclavable dynamometric  
Newtron® wrenches

**F12352**



**Autoclavable plastic box**  
for autoclavable dynamometric wrenches

**F12351**



**Newtron® kit support**

**F88452**

**Endo Success™ kit support**

**X88447**

**Perfect Margin™ kit support**

**X88448**

## Wrenches



**Newtron® wrench**  
autoclavable and dynamometric

**F81330**



**Universal wrench**

**F00406**



**Protec-Tip**

**F81281**

### Important

The Newtron® wrench is used with all blue, green and orange tips and with surgical endodontics tips (yellow): AS3D, AS6D, AS9D, ASLD, ASRD, S12-70D, P14D, P15LD and P15RD. For other tips with yellow ring, the universal wrench (Ref. F00406) is recommended.

## Accessories

	<b>Newtron® handpiece<sup>(1)</sup></b> without LED, autoclavable, light grey/dark grey for Newtron® Booster	<b>F12281</b>
	<b>Newtron® SLIM handpiece<sup>(1)</sup></b> without LED for Newtron® P5	<b>F12901</b>
	<b>Newtron® SLIM B.LED handpiece<sup>(1)</sup></b> for Newtron® P5 B.LED and Newtron® P5 XS B.LED (Bluetooth) with blue LED ring with white LED ring	<b>F12900</b> <b>F12905</b>
	<b>Grey nose</b> for Newtron® handpiece	<b>F12284</b>
	<b>Nose</b> for Newtron® SLIM and Newtron® SLIM B.LED handpieces	<b>E12904</b>
	<b>Newtron® SLIM B.LED blue LED ring</b>	<b>F62201</b>
	<b>Newtron® SLIM B.LED white LED ring</b>	<b>F12915</b>
	<b>Handpiece holder</b> silicone	<b>E60108</b>

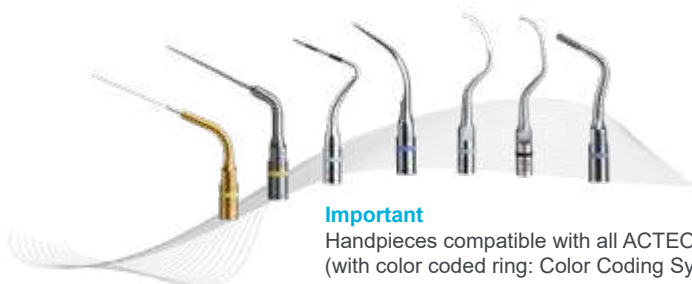

### Important

Handpieces compatible with all ACTEON® Equipment Dental Tips (with color coded ring: Color Coding System™)

(1) Dental ultrasonic handpiece - Class IIa medical devices (GMED) - CE 0459 - Manufacturer: SATELEC® ACTEON® Group - France



Newtron® Booster,  
Newtron® P5,  
Newtron® P5 B.LED,  
Newtron® P5 XS B.LED,  
Newtron® P5 XS B.LED Bluetooth

	<b>Newtron® handpiece cord</b> non-disconnectable for Newtron® Booster 4x6	<b>X00244</b>
	<b>Newtron® SLIM handpiece cord</b> non-disconnectable for Newtron® Booster	<b>X00227</b>
	<b>Newtron® SLIM handpiece cord</b> non-disconnectable for Newtron® P5	<b>X00228</b>
	<b>Newtron® SLIM B.LED handpiece cord</b> non-disconnectable for Newtron® P5 B.LED and Newtron® P5XS B.LED (Bluetooth)	<b>X00226</b>
	<b>Non-disconnectable footswitch</b> for Newtron® BOOSTER, Newtron® P5, Newtron® P5 B.LED and Newtron® P5XS B.LED (Bluetooth)	<b>F00061</b>
	<b>Dental plaque discloser</b> <b>F.L.A.G.™ for B.LED 5 x 1.5ml</b>	<b>F62200</b>
	<b>Dental plaque discloser</b> <b>F.L.A.G.™ for B.LED 100ml</b>	<b>F62203</b>
	<b>300ml tank</b> for Newtron® P5XS B.LED and Newtron® P5XS B.LED (Bluetooth)	<b>F62004</b>
	<b>500ml tank</b> for Newtron® P5XS B.LED and Newtron® P5XS B.LED (Bluetooth)	<b>F62005</b>

## Accessories

	<b>Newtron® handpiece<sup>(1)</sup></b> without LED, autoclavable, light grey/dark grey for Newtron® Booster	<b>F12281</b>
	<b>Newtron® LED handpiece<sup>(1)</sup></b> autoclavable for P-Max Newtron® XS, P5 Newtron® LED and P5 Newtron® XS LED	<b>F12609</b>
	<b>Grey nose</b> for Newtron® handpiece	<b>F12284</b>
	<b>Nose</b> for Newtron® LED handpiece	<b>E12681</b>
	<b>Light ring</b> for Newtron® LED handpiece	<b>F12605</b>
	<b>Non-disconnectable footswitch</b> for P5 Newtron®, P5 Newtron® LED, P5 Newtron® XS, P5 Newtron® XS LED	<b>F00061</b>
	<b>Universal irrigation lines<sup>(2)</sup> Sterile x10</b> single-use with integrated cassette and flow control system. For Sterikit and Sterikit LED	<b>F59905</b>
	<b>Pump cassette</b>	<b>E58543</b>



### Important

Handpieces compatible with all ACTEON® Equipment Dental Tips (with color coded ring: Color Coding System™)

(1) Dental ultrasonic handpiece - Class IIa medical devices (GMED) - CE 0459 - Manufacturer: SATELEC® ACTEON® Group - France  
(2) Class I medical device - CE - Manufacturer: SATELEC® ACTEON® Group - France



P5 Newtron®,  
P5 Newtron® LED,  
P5 Newtron® XS,  
P5 Newtron® XS LED,  
P-MAX Newtron® XS,  
Prophy Max™

	<b>White handpiece cord 4x6</b> for P5 Newtron® XS	<b>F00223</b>
	<b>White handpiece cord</b> for P5 Newtron® XS	<b>F00222</b>
	<b>LED handpiece cord 5x7</b> for P5 Newtron® LED and P5 Newtron® XS LED	<b>F00637</b>
	<b>Disconnectable LED handpiece cord</b> for P-Max Newtron® XS	<b>F00628</b>
	<b>Newtron® handpiece cord 5x7</b> white, with spray adjustment for Prophy-Max™	<b>F01176</b>
	<b>Tank</b> with white cover	<b>F58525</b>
	<b>Sterikit</b> for P5 Newtron® XS with a support, a bracket, a pump cover, 5 clips, a Sterijoint and 3 sterile universal irrigation lines <sup>(1)</sup>	<b>F58136</b>
	<b>Sterikit LED</b> for P5 Newtron® XS LED with a support, a bracket, a pump cover, 5 clips, a LED Sterijoint and 3 sterile universal irrigation lines <sup>(1)</sup>	<b>F58225</b>
	<b>Sterijoint</b> adapter for Newtron® handpiece for Sterikit	<b>F58703</b>
	<b>Sterijoint LED</b> adapter for Newtron® LED handpiece for Sterikit LED	<b>F12640</b>

(1) Irrigation line: irrigation set - Class Is medical device (GMED) - CE 0459 - Manufacturer: SATELEC® ACTEON® Group - France

## Accessories



**Newtron® handpiece<sup>(1)</sup>**  
without LED, autoclavable, light grey/dark  
grey for Newtron® Booster

**F12281**



**Grey nose** for Newtron® handpiece

**F12284**



**Newtron® Cart**  
Color: white

Two connections for water and electricity.  
Dimensions (DxWxH): 48 x 40 x 77cm  
3 glass trays: 42 x 36cm

**F03739**



### Important

Handpieces compatible with all ACTEON® Equipment Dental Tips  
(with color coded ring: Color Coding System™)



P5 Newtron® blue,  
P5 Newtron® XS blue,  
P-Max Newtron®,  
P-Max Newtron® Lux,  
Prophy Max™ blue,  
Prophy Max™ Lux



**Kit of 3 hoops**  
for Newtron® cord

**F59761**



**Newtron® Tank - 450ml**  
For P-Max Newtron® (Lux) and  
Prophy Max™ (Lux)

**E59774**



**Newtron® Tank cap**  
For P-Max Newtron® (Lux) and  
Prophy Max™ (Lux)

**E59775**



**Newtron® single footswitch**

**F00054**



**Newtron® double footswitch**

**F00055**

## Accessories

	<b>Newtron® handpiece<sup>(1)</sup></b> without LED, autoclavable, light grey/dark grey for Newtron® Booster	<b>F12281</b>
	<b>Self-adhesive holder</b> for light grey Suprasson handpiece	<b>F00404</b>
	<b>Bulb for light handpiece cord + 2 o'rings</b>	<b>F00412</b>
	<b>3 gasket o'rings + tool</b>	<b>F12304</b>
	<b>Light grey Suprasson handpiece cord</b>	<b>F00195</b>
	<b>Cocoon Cart</b> Color: white  Two connections for water and electricity Dimensions (DxWxH) : 45 x 40 x 80cm 3 trays: 40 x 30cm	<b>F24417</b>
	<b>Single footswitch</b>	<b>F00045</b>









(1) Dental ultrasonic handpiece - Class IIa medical devices (GMED) - CE 0459 - Manufacturer: SATELEC® ACTEON® Group - France



	<b>Sterijoint</b> adapter for Newtron® handpiece for Sterikit	<b>F58703</b>
	<b>Universal irrigation lines<sup>(1)</sup> Sterile</b> x10 single-use with integrated cassette and flow control system. For Sterikit and Sterikit LED	<b>F59905</b>
	<b>5 plastic caps kit</b> for universal irrigation line	<b>F57375</b>
	<b>Bracket</b>	<b>X34510</b>
	<b>Stoppers kit x10</b> for irrigation bottle	<b>F58790</b>
	<b>Autoclavable irrigation bottle (glass)</b>	<b>E58795</b>
	<b>Autoclavable irrigation bottle (glass)</b> with grey cap	<b>F58792</b>
	<b>Grey cap</b>	<b>F58794</b>
	<b>Hanger</b> for irrigation bottle	<b>E58791</b>
	<b>Sterilstatic irrigation kit</b> with a pump motor, a holder, 3 universal irrigation lines <sup>(1)</sup> , 5 clips, 3 hanger for bottle, 3 stoppers, a bracket and a bottle with grey cap	<b>F58704</b>
	<b>Steel water filter 60µ complete</b>	<b>F10386</b>
	<b>Water filter 60µ cartridge + o'ring</b>	<b>F10389</b>

(1) Irrigation line - irrigation set - Class Is medical device (GMED) - CE 0459 - Manufacturer: SATELEC® ACTEON® Group - France

Devices	Corresponding lines	Designation	REF.
 <p>1 - Suprasson P-Max (Lux) Assortiment I                  2 - Prophy Max™ (Lux) Assortiment I                  3 - P5 Newtron® XS (LED) + Sterikit                  4 - Suni 2<sup>nd</sup> generation                  5 - Suni Max                  6 - Trans'care Max</p>		<p><b>Universal irrigation lines<sup>(1)</sup> sterile x10</b>                      single-use with integrated cassette and flow control system</p>	<p><b>F59905</b></p>
 <p>7 - Piezotome®                  8 - Piezotome® 2                  9 - ImplantCenter™                  10 - ImplantCenter™ 2                  11 - Piezotome® Solo                  12 - Piezotome® Cube                  13 - I-Surge™ old generation                  14 - I-Surge™                  15 - EndoCenter</p>		<p><b>Autoclavable irrigation lines<sup>(2)</sup> x1</b>                      + 10 sterile perforators<sup>(3)</sup></p> <hr/> <p><b>Autoclavable irrigation lines<sup>(2)</sup> x1</b></p> <hr/> <p><b>Disposable sterile perforators<sup>(3)</sup> x10</b></p>	<p><b>F57374</b></p> <hr/> <p><b>E59920</b></p> <hr/> <p><b>F57372</b></p>
 <p>16 - I-Surge™ +                  17 - HT-Implant</p>		<p><b>Irrigation lines<sup>(1)</sup> x10</b></p>	<p><b>F28750</b></p>

(1) Irrigation set - Irrigation line - Class Is medical device (GMED) - CE 0459 - Manufacturer: SATELEC® ACTEON® Group - France  
 (2) Class I medical device - CE - Manufacturer: SATELEC® ACTEON® Group - France  
 (3) Class Is medical devices (GMED) - CE 0459 - Manufacturer: PROMEPLA - Distributor: SATELEC® ACTEON® Group - France

# POLISHERS

.....

<b>AIR-N-GO® easy</b>	<b>128</b>
<b>PROPHY MAX</b>	<b>132</b>
<b>AIR MAX</b>	<b>133</b>
<b>Powders</b>	<b>135</b>





# All-in-one for easy procedures

# air-n-go easy



### All-in-one airpolisher for easy procedures

- Supra and sub-gingival use
- Optimal space
- Ready to use

**AIR-N-GO® easy with KaVo\* adapter** **F10100**

**AIR-N-GO® easy with Sirona\* adapter** **F10101**

**AIR-N-GO® easy with W&H\* adapter** **F10102**

**AIR-N-GO® easy with Bien-Air\* adapter** **F10103**

**AIR-N-GO® easy with Midwest\* adapter** **F10105**

with a convertible AIR-N-GO® easy handpiece, a Supra nozzle, 1 AIR-N-GO® easy maintenance kit (replacement o'rings, syringe of silicone grease with brushes, cannula, cleaning drill)

Dental air-polishing handpiece - Class IIa medical device (GMED) - CE 0459 - Manufacturer: SATELEC® ACTEON® Group - France

## Accessories



**AIR-N-GO® easy Perio kit<sup>(1)</sup>**  
turns your handpiece into a Perio system to treat periodontal disease (tooth & implants) on pockets from 3 to 8mm. with a AIR-N-GO® easy nozzle and a bottle of AIR-N-GO® PERIO glycine powder

**F10120**



**AIR-N-GO® Supra nozzle**  
for all prophylaxis supra-gingival treatments

**F10125**



**AIR-N-GO® Perio easy nozzle**  
turns your handpiece into a Perio system to treat non surgical periodontal disease (tooth & implants) in pockets from 3 to 8mm

**F10126**



**AIR-N-GO® Perio nozzle**  
turns your handpiece into a Perio system to treat non surgical periodontal disease (tooth & implants) in pockets from 3 to 8mm

**F10127**



**AIR-N-GO® Perio Maintenance nozzle**  
turns your handpiece into a system adapted for periodontal maintenance in pockets until 4mm

**F10128**



**AIR-N-GO® easy maintenance kit**

**F10121**

## Adapters



KaVo\* Adapter

F10240



Sirona\* Adapter

F10241



W&amp;H\* Adapter

F10242



Bien-Air\* Adapter

F10243



Midwest\* Adapter

F10245

## Accessories



AIR-N-GO® Supra nozzle

F10125



AIR-N-GO® Perio nozzle

F10127



AIR-N-GO® Perio tank

F10216



AIR-N-GO® Supra probe Ø0.5mm

F10207



AIR-N-GO® Supra probe Ø1mm

F10208



AIR-N-GO® Perio probe

F10206



AIR-N-GO® o-rings kit

F10205



## prophymax

Combinated device with ultrasonics and airpolisher

### ProphyMax™

**F11610**

with a ProphyPen handpiece with 135° titanium nozzle, an autoclavable universal wrench, a bottle of mint powder (250g) and a bottle of lemon powder (250g), an autoclavable Newtron® handpiece, a double footswitch

Dental polishing and ultrasonic control console  
Class IIa medical device (GMED) - CE 0459 - Manufacturer: SATELEC® ACTEON® Group - France

### Important

You will find all the information about ultrasonics accessories (tips, handpieces, etc) on pages 106 to 113.



## air max

Supra-gingival airpolisher

### Air Max

**F11400**

with a ProphyPen handpiece with 135° titanium nozzle, an autoclavable universal wrench, a bottle of mint powder (250g) and a bottle of lemon powder (250g)

Dental polishing control console - Class IIa medical device (GMED) - CE 0459 - Manufacturer: SATELEC® ACTEON® Group - France

## Accessories



**Blue ProphyPen<sup>(1)</sup>**  
Disconnectable polisher handpiece (bayonet) with a 135° titanium nozzle and an autoclavable universal wrench

**F10554**



**White ProphyPen**  
Disconnectable polisher handpiece (bayonet) with a 135° titanium nozzle and an autoclavable universal wrench

**F10557**



**Titanium nozzle 135°** Ø0.7 mm

**F10555**



**Probe** Ø0.7mm

**E96221**



**Probe** Ø1mm

**F10208**



**Multifunctions double footswitch**

**F00055**



**2 ProphyPen o-rings**  
+ 1 nozzle o-ring kit

**F10374**



**4 o-rings kit for ProphyPen handpiece cord**

**F10375**

(1) Dental air-polishing handpiece - Class IIa medical device (GMED) - CE 0459 - Manufacturer: SATELEC® ACTEON® Group - France

## Powders

**AIR-N-GO® "CLASSIC" powder<sup>(1)</sup>**  
4 bottles (250g)

**Peppermint**

**F10250**

**Lemon**

**F10251**

**Raspberry**

**F10252**

**Cola**

**F10253**

**Neutral**

**F10254**



**AIR-N-GO® "CLASSIC" powder<sup>(1)</sup>**  
4 flavors (peppermint, Lemon, Raspberry and cola)  
4 bottles (250g)

**F10255**



**AIR-N-GO® "PERIO" powder<sup>(2)</sup>**  
3 bottles (160g)

**F10270**

(1) Class IIa medical device - (GMED) - CE 0459 - Manufacturer: SATELEC® ACTEON® Group - France

(2) Powder for subgingival treatment of periodontitis and peri-implantitis - Class IIa medical device - (GMED) - CE 0459 - Manufacturer: SATELEC® ACTEON® Group - France

# CURING LIGHT

.....

<b>MiniLED™ Range</b>	<b>138</b>
<b>MiniLED™ Active</b>	<b>139</b>
<b>MiniLED™ Supercharged</b>	<b>140</b>
<b>MiniLED™ Ortho 2</b>	<b>141</b>
<b>MiniLED™ Standard</b>	<b>142</b>



## Fast curing, long term results



# miniled

### A fast curing for aesthetics result

- Fast and powerful treatment
- Adapted to the act
- Long battery life



miniled  
active

**Ready to use**



miniled  
supercharged

**Powerful**



miniled  
ortho 2

**Adaptable**



miniled  
standard

**Classic**

# miniled active



Wavelength: 420 - 480nm

Power: 1492mW/cm<sup>2</sup>

Li-Ion battery

Handpieces: anodized aluminium

### MiniLED™ Active

**F05100**

with a MiniLED™ handpiece, an universal power supply cord, a Ø7.5mm opalescent guide and an oval light shield

Dental curing light - Class I medical devices - CE - Manufacturer: SATELEC® ACTEON® Group - France

# miniled supercharged

**Wavelength: 420 - 480nm**

**Power: 2000mW/cm<sup>2</sup>**

**Li-Ion battery**

**Handpieces: anodized aluminium**



## MiniLED™ Supercharged

**F05214**

with a MiniLED™ handpiece, a battery, a battery charger, a power supply + 4 plugs, a Ø7.5mm opalescent light guide and light shield

Dental curing light - Class I medical devices - CE - Manufacturer: SATELEC® ACTEON® Group - France

# miniled ortho 2

**Wavelength: 420 - 480nm**

**Power: 3000mW/cm<sup>2</sup>**

**Li-Ion battery**

**Handpieces: anodized aluminium**



## MiniLED™ Ortho 2

**F05220**

with a MiniLED™ handpiece, a Ø5.5mm opalescent guide, a power supply + 4 plugs, a battery, a battery charger and an oval light shield

Dental curing light - Class I medical devices - CE - Manufacturer: SATELEC® ACTEON® Group - France

# miniled standard

Wavelength: 420 - 480nm

Power: 1250mW/cm<sup>2</sup>

Li-Ion battery

Handpieces: anodized aluminium



## MiniLED™ Standard

**F02507**

with a MiniLED™ handpiece, a battery, a battery charger, a power supply cord with european plug, a Ø7.5mm opalescent guide and an oval light shield

Dental curing light - Class I medical devices - CE - Manufacturer: SATELEC® ACTEON® Group - France

## Accessories

MiniLED™ Supercharged handpiece<sup>(1)</sup> **F05217**

MiniLED™ Ortho 2 handpiece<sup>(1)</sup> **F05219**

MiniLED™ Standard handpiece<sup>(1)</sup> **F02530**



**Charger**  
for MiniLED™ Supercharged,  
MiniLED™ Ortho2 and  
MiniLED™ Autofocus2

**F02917**

Charger for MiniLED™ MiniLED™ Standard **F02510**



**Titanium battery**  
for MiniLED™ Supercharged,  
MiniLED™ Ortho2 and  
MiniLED™ Autofocus2

**F05211**

Titanium battery for MiniLED™ Standard **F02520**



**Oval light shield**  
for MiniLED™ Active, MiniLED Ortho2,  
MiniLED™ Supercharged and  
MiniLED™ Autofocus2

**F05407**



**Oval light shield**  
for MiniLED™ Standard

**F02555**



## Accessories



**Universal power supply**  
for MiniLED™ Active

**F05120**



**Universal power supply**  
for MiniLED™ Supercharged,  
MiniLED™ Ortho2 and  
MiniLED™ Autofocus2

**F05216**



**European power supply**  
for MiniLED™ Standard

**F02543**



**Opalescent light guide Ø7.5mm**  
for MiniLED™ Active

**F05121**



**Opalescent light guide Ø7.5mm**  
for MiniLED™ Standard, MiniLED™ Ortho2  
and MiniLED™ Supercharged

**F02648**



**Autoclavable caps Ø7.5mm x5**  
for MiniLED™ Standard, MiniLED™ Ortho2,  
MiniLED™ Supercharged and  
MiniLED™ Autofocus2

**F61507**



**Autoclavable caps Ø5.5mm x5**  
for MiniLED™ Standard, MiniLED™ Ortho2,  
MiniLED™ Supercharged and  
MiniLED™ Autofocus2

**F61505**



**Autoclavable caps Ø7.5mm x5**  
**Autoclavable caps Ø5.5mm x5**  
for MiniLED™ Standard, MiniLED™ Ortho2,  
MiniLED™ Supercharged and  
MiniLED™ Autofocus2

**F61515**

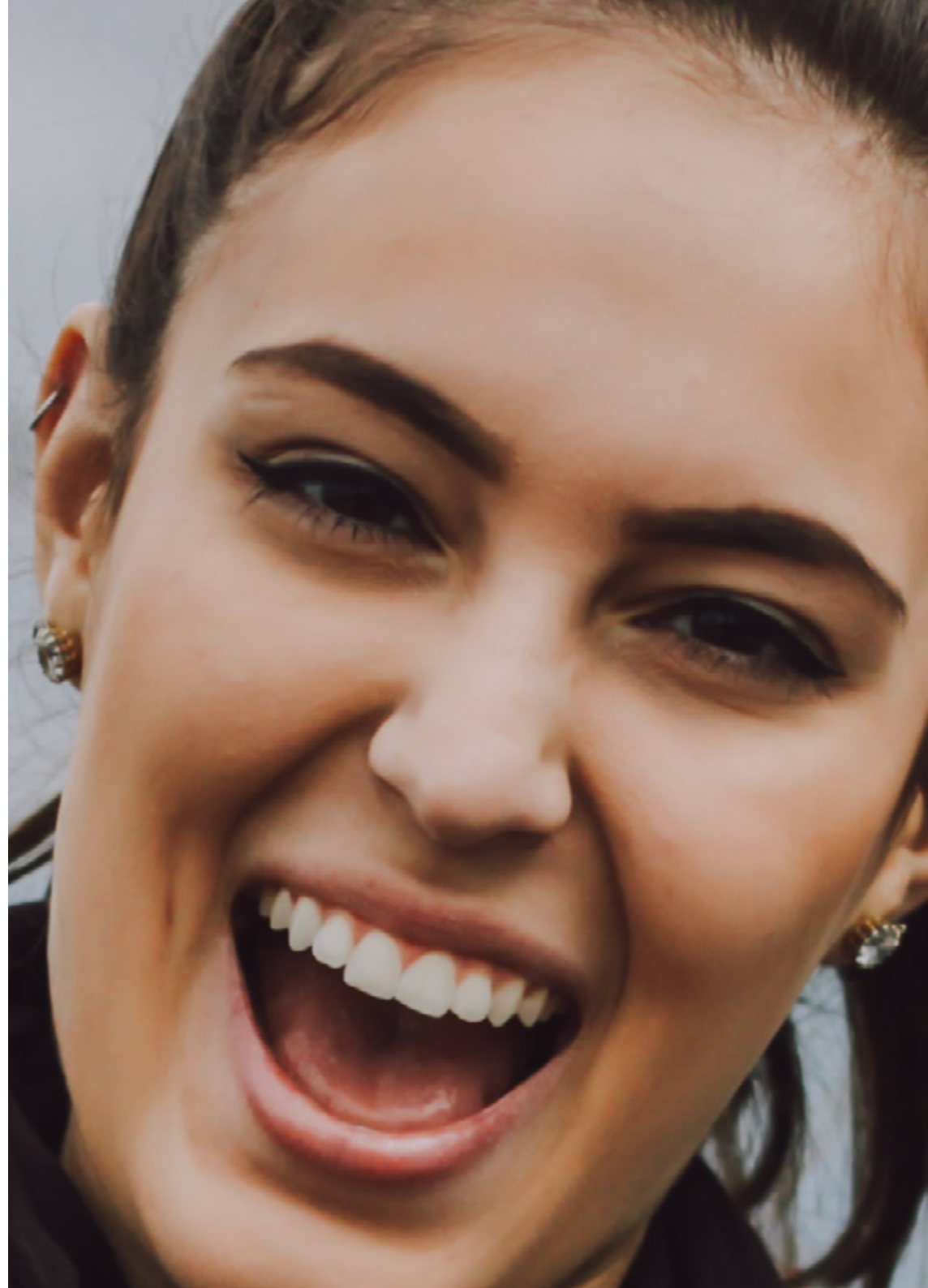

# MISCELLANEOUS

.....

<b>SOFTLY</b>	<b>148</b>
Cocoon Hygienist LED	149
Trans'care	149
Quaz	150
Endocenter & EndoDual	152
Vela 170	152



# softly



## Amalgamator

### Pre-measured capsules amalgamator

External dimensions:

210 x 205 x 120mm (D x W x P)

Weight: 3.1kg

Softly

6.01.00112

## Cocoon Hygienist LED



Light motor<sup>(1)</sup>

F28600



Medium grey cord  
for light and IS motors

F33711

## Trans'care



Light motor<sup>(1)</sup>

F28600



Light motor black  
coiled cord

F33713

## Quaz



### Quaz® Dem 5.30

demineralizer with distilled water quality sensor  
compatible with Quaz® 5.17 & 5.24

**F03931**

### Quaz® Dem 6.30

Demineralizer  
compatible with Quaz® 6.17 & 6.24

**F03932**

### Filter cartridge 30"

for Quaz® Dem 5.30 & 6.30

**F03933**

### Filter cartridge 20"

for Quaz® Dem 5.20 & 6.20

**F03914**

### Filter cartridge 10"

for Quaz® Dem 5.10 & 6.10

**F03919**



### Quaz® Print

barcode printer (on labels)

**F03927**



**2 stickers rolls + 2 ribbons**  
for Quaz® print

**F03928**



### Printer "Quaz® printer" 230V'

Discontinued, available until stock runs out

**F03909**



**Sterilization box**

**F03912**



**Tube for automatic filling**

**F03910**



**Tube for automatic emptying**

**F03911**



**Bacteriological filter**

**F03904**



## Endocenter & EndoDual



**Universal irrigation lines<sup>(1)</sup> Sterile** x10  
single-use with integrated cassette and  
flow control system

**F59905**



**Autoclavable irrigation line<sup>(2)</sup> x1**  
+ 10 sterile perforators<sup>(3)</sup>

**F57374**



**Disposable sterile perforators<sup>(3)</sup> x10**

**F57372**



**ENDOCENTER power supply**

**F28955**



**Handpiece holder**  
silicone

**E60108**

## Vela 170



**Carrier for sterilization bags**

**E03558**



**Tube for filling vacuum**  
+ male connector

**E03648**



(1) Irrigation set - Irrigation line - Class Is medical device (GMED) - CE 0459 - Manufacturer: SATELEC® ACTEON® Group - France

(2) Class I medical device - CE - Manufacturer: SATELEC® ACTEON® Group - France

(3) Class Is medical devices (GMED) - CE 0459 - Manufacturer: PROMEPLA - Distributor: SATELEC® ACTEON® Group - France





---

# ACTEON® INSTRUMENTS

<b>BLISS Range</b>	<b>156</b>
<b>Mirror Range</b>	<b>168</b>
<b>Diagnostic instruments</b>	<b>180</b>
<b>Restoration instruments</b>	<b>186</b>
<b>Prosthesis instruments</b>	<b>192</b>
<b>Periodontic instruments</b>	<b>196</b>
<b>Endosurgery instruments</b>	<b>200</b>
<b>Extraction instruments</b>	<b>208</b>
<b>Surgery instruments</b>	<b>224</b>
<b>Implantology instruments</b>	<b>232</b>
<b>Orthodontic instruments</b>	<b>244</b>
<b>Accessories</b>	<b>248</b>

# BLISS® RANGE

.....

<b>Bliss® Range</b>	<b>158</b>
<b>Bliss® kits</b>	<b>160</b>
<b>Bliss® Gracey curettes</b>	<b>162</b>
<b>Bliss® Sickles instruments</b>	<b>162</b>
<b>Bliss® Universal curettes</b>	<b>163</b>
<b>Bliss® Dual Ends instruments</b>	<b>163</b>
<b>Bliss® Diagnostic instruments</b>	<b>164</b>
<b>Bliss® Periodontics instruments</b>	<b>164</b>
<b>Bliss® Restoration instruments</b>	<b>165</b>
<b>Bliss® Endodontic instruments</b>	<b>166</b>
<b>Bliss® Mirror handle</b>	<b>167</b>





# bliss

## Superior comfort at your fingertips

### The next generation of manual instrumentation

- Lightweight: 15g
- Unique "Soft Touch" grip
- Long lasting sharpness<sup>(1)</sup>
- 100% approved by practitioners<sup>(2)</sup>

### UNCONVENTIONALLY DURABLE AND SOLID

- High wear-resistance due to the stainless steel properties
- The metal is treated in accordance with the latest heating techniques

### ENHANCED COMFORT THE FINAL GOAL

- High sharpness means less force
- Less force means less muscle fatigue
- Less force means comfortable scaling

Manual instrumentation video



### TRUE ERGONOMICS

- 10mm: optimal handle diameter to reduce pinch force<sup>(3)</sup>
- 15g: ultra light to limit hand fatigue<sup>(3)</sup>

### UNIQUE COMFORT

- Flat areas for the fingers, to avoid localized pressure
- Intrinsic tactile sensation

### GENTLE AND CONFIDENT GRIP

- Effective «soft touch» non-slip surface
- Firm silicone with no spring effect for an accurate and controlled clinical gesture

### REVOLUTIONARY COMFORT AT YOUR FINGERTIPS

#### 42 instruments

- Diagnostic
- Restoration
- Periodontics
- Endodontics
- Prophylaxis



(1) The effects of periodontal instrument handle on hand muscle load and pinch force, D. Rempel; D. Lee; K. Dawson; P. Loomer; JADA 143 (10) - October 2012.

(2) Internal field evaluation on 20 practitioners from 8 different countries. 100% answered that Bliss handle was comfortable.

(3) Rempel D, Lee D.L., Dawson K, Loomer P. The effects of periodontal curette handle weight and diameter on arm pain. JADA. 2012 Oct;143(10)



## Kits

Every consultation starts with these 3 instruments

One end of the handle is flat to facilitate percussive diagnostics, allowing to evaluate the sensitivity and the mobility of the tooth and the sensitivity of the gum.



### Diagnostic kit Bliss®

with an Easy Clip cassette, 1 EXP17-23,  
1 College tweezers 15cm satin finishing  
**mirror handle SS + 1 PureReflect® mirror**  
**mirror handle CSS + 1 PureReflect® mirror**

*402SS.SI*  
*402CSS.SI*



### Care kit Bliss®

with an Easy Clip cassette, 1 EXP17-23,  
1 CMS2, 1 College tweezers 15cm satin  
finishing  
**mirror handle SS + 1 PureReflect® mirror**  
**mirror handle CSS + 1 PureReflect® mirror**

*403SS.SI*  
*403CSS.SI*

The design is accurate and thin, ideal to draw furrows and cuspids. The ergonomic and unique design of Bliss® handle offer comfort and precision of the clinical gesture.

This is essential for restoration work when modelling and sculpting the composite.



### Restoration kit Bliss®

with an Easy Clip cassette, 1 EXP17-23,  
1 CMS4, 1 CMS2, 1 BUR125,  
1 EXC38-37, 1 EXC91, 1 College tweezers  
15cm satin finishing  
**mirror handle SS + 1 PureReflect® mirror**  
**mirror handle CSS + 1 PureReflect® mirror**

*404SS.SI*  
*404CSS.SI*

The high wear resistance combined with the optimal hardness of the metallic blade make the sharp instruments efficient and long-lasting.



### Prophylaxis kit Bliss®

with an Easy Clip cassette, 1 UNC12,  
1 M23, Gracey curettes 11-12 and 13-14,  
1 H6-H7, 1 Columbia curette 13-14  
**mirror handle SS + 1 PureReflect® mirror**  
**mirror handle CSS + 1 PureReflect® mirror**

*400SS.SI*  
*400CSS.SI*

It includes 11 manual instruments covering most of orthograde endodontic procedures and conservative dentistry: cleaning the cavity, obturation of the access cavity, reprocessing and restoration.



### Endodontic kit Bliss®

with a cassette, 1 Self-Blocking tweezers,  
1 CP15, 1 EX37-38, 1 EX91, 1 SP25,  
1 CMS6, 1 Machtou 1-1, 1 Machtou 1-2,  
1 Machtou 2-3, 1 Machtou 2-4, 1 endo files  
holder  
**mirror handle SS + 1 PureReflect® mirror**  
**mirror handle CSS + 1 PureReflect® mirror**

*401SS.SI*  
*401CSS.SI*

## Gracey curettes



Gracey curette 1-2

402.01SI



Gracey curette 3-4

402.03SI



Gracey curette 5-6

402.05SI



Gracey curette 11-12

402.11SI



Gracey curette 13-14

402.13SI



Gracey curette 15-16

402.15SI



Gracey curette 17-18

402.17SI

## Sickles



Sickle - M23

404.23SI



Sickle - H6-H7

406.07SI



Micro CK6

404.05SI

## Universal curettes



Universal curette - Barnhart 5-6

408.05SI



Universal curette - Columbia 4L-4R

405.04SI



Universal curette - Columbia 13-14

405.13SI



Universal curette - Langer 5-6

406.06SI



Universal curette - Langer 5-6 mini

406.10SI

## Dual ends



Dual End - H5-L5

406.05SI



Dual End - N128-L5

406.08SI



Dual End - N128-L5 mini

406.09SI

## Diagnostics



EXP11-12 - Explorer

263.06SI



EXP17-23 - Explorer

263.07SI

## Periodontics



UNC12 - graduated 1 to 12mm - Expro

418.06SI



CP12 - graduated 3-6-9-12mm - Expro

418.07SI



UNC15 - graduated 1 to 15mm - Expro

418.08SI



CP12 - graduated 3-6-9-12-15mm - Expro

418.09SI

## Restoration



EXC36-35 - Excavator

165.01SI



EXC38-37 - Excavator

165.02SI



EXC91 - Excavator

165.03SI



BUR125 - Burnisher

108.14SI

w 1.8mm  
CM1 - Modeling spatula

194.12SI

w 2mm  
CM2 - Modeling spatula

194.13SI

L 5.4mm  
CM3 - L4/5.4mm - Modeling spatula

194.14SI

L 4mm  
CM4 - L4/5.6mm - Modeling spatula

194.15SI

L 1.6mm  
CM5 - L1.6/1.6mm - Modeling spatula

194.16SI

L 1.6mm  
CM6 - L1.6/1.6mm for molars - Modeling spatula

192.05SI

## Restoration



SP20 - 20mm - Cement spatula

246.05SI



SP25 - 25mm - Cement spatula

246.09SI



SP42 - 42mm - Cement spatula

246.24SI

## Endodontics



Machtou 1-1 - Plugger

419.01SI



Machtou 1-2 - Plugger

419.02SI



Machtou 2-3 - Plugger

419.03SI



Machtou 2-4 - Plugger

419.04SI

## Mirror handle



Mirror handle EU stem\*  
Mirror handle CSS\*

210.00SI  
212.00SI

\* mirror sold separately - Pure Reflect size 5: MP4624PH (CSS) - MP3624PH (EU Stem)



# MIRROR RANGE

.....

<b>Mirror Range</b>	<b>170</b>
<b>Mouth mirrors SS</b>	<b>172</b>
<b>Top range mirrors</b>	<b>174</b>
<b>Micromirrors SS</b>	<b>175</b>
<b>Photographic mirrors &amp; Contrastors</b>	<b>176</b>
<b>Mouth mirrors CSS</b>	<b>178</b>
<b>Micromirrors CSS</b>	<b>178</b>
<b>Handles</b>	<b>179</b>

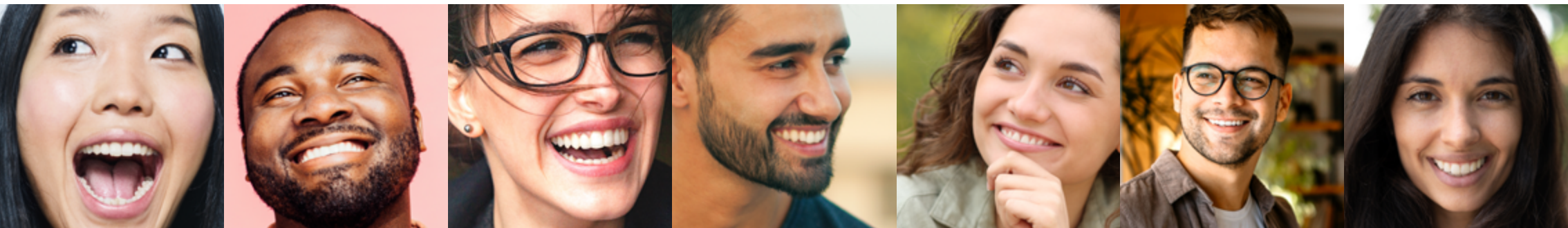

# Perfect clarity, crystal-clear vision

## MOUTH MIRRORS – FROM DIAGNOSTIC TO TREATMENT, THE BENEFIT TO ALL DENTAL CLINICAL ACTS



- Visual examination is the first step to diagnostics
- 10 different sizes
  - From 0 to 6 to work in the mouth
  - From 7 to 10 to clinical studies, photography

## MICROMIRRORS – THE MICROSCOPIC PERFECTLY VISIBLE



- Make the access to the apex easier and appreciate the accurate vision of the pulp chamber.
- 4 different sizes

## PHOTOGRAPHIC MIRRORS – EFFECTIVE COMMUNICATION WITH PATIENTS



- Highlight the dental treatment and restoration to promote the practice. Allow to take pictures of clinical cases for books, publications and patient records.
- 8 different sizes for occlusal, vestibular and lingual areas.

Our mirrors resist to more than 100 autoclave cleaning cycles\*



Mirrors has to be replaced after 3 MONTHS of daily use

## Front surface

Cross-sectional view

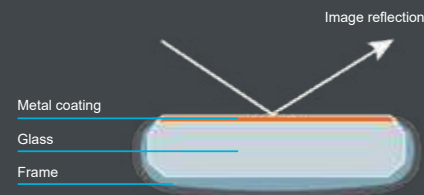
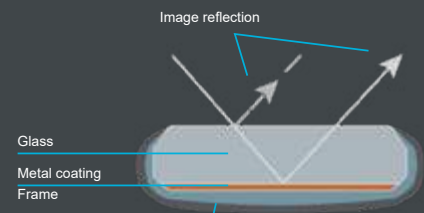

Image reflected directly on the surface of the glass, distortion-free  
**NO DOUBLE IMAGE**

## Back surface

Cross-sectional view of an aluminium mirror



Reflecting surface under the glass  
**DOUBLE IMAGE**



## The finition of the frame also matters

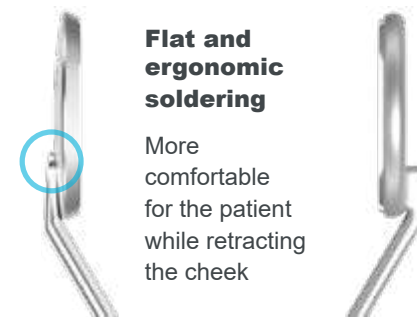

**Flat and ergonomic soldering**

More comfortable for the patient while retracting the cheek

ACTEON®

Competitors

## Satined finition

Prevent light reflection in the eyes  
Avoid eye fatigue

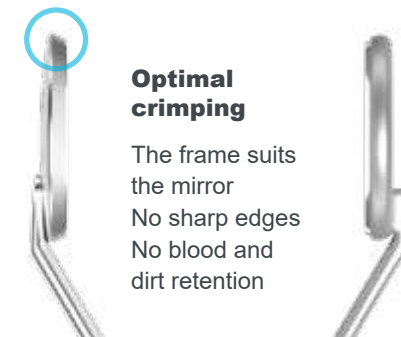







**Optimal crimping**

The frame suits the mirror  
No sharp edges  
No blood and dirt retention

ACTEON®

Competitors

## Mouth mirrors simple stem

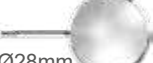
 Ø14mm	<b>n.0</b> Plan mirror	Pure Reflect® mirror - x12	<b>MP3614PH</b>
 Ø16mm	<b>n.1</b> Plan mirror	Pure Reflect® mirror - x12	<b>MP3616PH</b>
 Ø18mm	<b>n.2</b> Plan mirror	RH mirror - x12 Pure Reflect® mirror - x12	<b>MP3318PH</b> <b>MP3618PH</b>
 Ø20mm	<b>n.3</b> Plan mirror	Alu mirror - x12 RH mirror - x12 Pure Reflect® mirror - x12	<b>MP3120PH</b> <b>MP3320PH</b> <b>MP3620PH</b>
 Ø22mm	<b>n.4</b> Plan mirror	Alu mirror - x12 Alu mirror - x20 RH mirror - x12 Pure Reflect® mirror - x12	<b>MP3122PH</b> <b>MPV3122PH</b> <b>MP3322PH</b> <b>MP3622PH</b>
 Ø24mm	<b>n.5</b> Plan mirror	Alu mirror - x12 Alu mirror - x20 RH mirror - x12 Pure Reflect® mirror - x12	<b>MP3124PH</b> <b>MPV3124PH</b> <b>MP3324PH</b> <b>MP3624PH</b>
 Ø26mm	<b>n.6</b> Plan mirror	Alu mirror - x12 RH mirror - x12 Pure Reflect® mirror - x12	<b>MP3126PH</b> <b>MP3326PH</b> <b>MP3626PH</b>
 Ø28mm	<b>n.7</b> Plan mirror	Alu mirror - x1 Pure Reflect® mirror - x1	<b>MP3128PH</b> <b>MP3628PH</b>

 Ø30mm	<b>n.8</b> Plan mirror	Alu mirror - x1 RH mirror - x1 Pure Reflect® mirror - x1	<b>MP3130PH</b> <b>MP3330PH</b> <b>MP3630PH</b>
 Ø40mm	<b>n.9</b> Plan mirror	Alu mirror - x1 RH mirror - x1 Pure Reflect® mirror - x1	<b>MP3140PH</b> <b>MP3340PH</b> <b>MP3640PH</b>
 Ø55mm	<b>n.10</b> Plan mirror	Alu mirror - x1 Pure Reflect® mirror - x1	<b>MP3155PH</b> <b>MP3655PH</b>
	<b>n.4</b> Double sided mirror	RH mirror - x12 RH mirror - x6 Pure Reflect® mirror - x12 Pure Reflect® mirror - x6	<b>MP7322PH</b> <b>MP7422PH</b> <b>MP7822PH</b> <b>MP7722PH</b>
	<b>n.5</b> Double sided mirror	RH mirror - x12 RH mirror - x6 Pure Reflect® mirror - x12 Pure Reflect® mirror - x6	<b>MP7324PH</b> <b>MP7424PH</b> <b>MP7824PH</b> <b>MP7724PH</b>
 Ø22mm	<b>n.4</b> Magnifying mouth mirror x3.5	Alu mirror - x12	<b>MP3222PH</b>
 Ø24mm	<b>n.5</b> Magnifying mouth mirror x3.5	Alu mirror - x12	<b>MP3224PH</b>

## Top range mirrors



Holy plan mirror n.4 - Alu mirror x12

**MP105122PH**

Holy Clar plan mirror n.4 - Alu mirror x12

**MP105222PH**



DMS plan mirror n.4 - RH mirror x12

**MP103322DMS**

DMS plan mirror n.5 - RH mirror x12

**MP103324DMS**



Colored plastic mirrors - Alu mirror x36  
Ø22mm - Plastic mounting - Autoclavable - 7 colors

**MP8122MPH**

## Micromirrors



Pure Reflect® Micromirror SS Ø3mm - round

**MP3303PH**



Pure Reflect® Micromirror SS Ø5mm - round

**MP3305PH**



Pure Reflect® Micromirror SS 7x2mm - rectangular

**MP3306RPH**



Pure Reflect® Micromirror SS 9x3mm - rectangular

**MP3310RPH**



Pure Reflect® Micromirror Ø3mm - 14.8cm - round

**MP1303PH**



Pure Reflect® Micromirror Ø5mm - 14.8cm - round

**MP1305PH**



Pure Reflect® Micromirror 7x2mm - 14.8cm - rectangular

**MP1306RPH**



Pure Reflect® Micromirror 9x3mm - 14.8cm - rectangular

**MP1310RPH**



## Double sided photographic mirrors



Occlusal surface adult

Tl coating  
Chromium coating  
Pure Reflect® coating

*MZP511.*  
*MZP512.*  
*MZP516.*



Occlusal surface child

Tl coating  
Chromium coating  
Pure Reflect® coating

*MZP521.*  
*MZP522.*  
*MZP526.*



Vestibular surface

Tl coating  
Chromium coating  
Pure Reflect® coating

*MZP531.*  
*MZP532.*  
*MZP536.*



Thin lingual surface

Tl coating  
Chromium coating  
Pure Reflect® coating

*MZP541.*  
*MZP542.*  
*MZP546.*



Large lingual surface

Tl coating  
Chromium coating  
Pure Reflect® coating

*MZP551.*  
*MZP552.*  
*MZP556.*



Lateral shape

Tl coating  
Chromium coating  
Pure Reflect® coating

*MZP561.*  
*MZP562.*  
*MZP566.*



Large occlusal surface

Tl coating  
Chromium coating  
Pure Reflect® coating

*MZP571.*  
*MZP572.*  
*MZP576.*



Extra large occlusal surface

Tl coating  
Chromium coating  
Pure Reflect® coating

*MZP581.*  
*MZP582.*  
*MZP586.*

## Contrastors



Contrastor n.4 small straight design  
240x60x1.5mm

*MZP215*



Contrastor n.5 large straight design  
240x60x1.5mm

*MZP216*



Contrastor n.3  
73x70mm

*MZP217*



Contrastor n.1  
84x85mm angular



*MZP218*







Contrastor n.2  
59x70mm angular

*MZP219*

## Mouth mirrors cone socket stem\*

	<b>n.4</b> Plan mirror	TI mirror - x12 Pure Reflect® mirror - x12	<b>MP4522PH</b> <b>MP4622PH</b>
	<b>n.5</b> Plan mirror	Alu mirror - x12 RH mirror - x12 TI mirror - x12 Pure Reflect® mirror - x12	<b>MP4124PH</b> <b>MP4324PH</b> <b>MP4524PH</b> <b>MP4624PH</b>
	<b>n.5</b> Magnifying mouth mirror x3.5	Alu mirror - x12	<b>MP4224PH</b>









## Micromirrors cone socket stem\*

	<b>Pure Reflect® Micromirror CSS*</b> Ø3mm - round	<b>MP4303PH</b>
	<b>Pure Reflect® Micromirror CSS*</b> Ø5mm - round	<b>MP4305PH</b>
	<b>Pure Reflect® Micromirror CSS*</b> 7x2mm - rectangular	<b>MP4306RPH</b>
	<b>Pure Reflect® Micromirror CSS*</b> 9x3mm - rectangular	<b>MP4310RPH</b>

\* USA, Canada, Spain, South Korea

Class I professional dental medical devices - CE - Manufacturer: PRODONT HOLLIGER ACTEON® Group - France

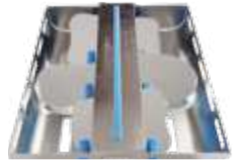
## Accessories

	<b>XLstyle</b> handle	XLStyle mirror handle EU stem XLStyle mirror handle CSS*	<b>210.00XL</b> <b>212.00XL</b>
	<b>Design</b> handle	Design mirror handle EU stem Design mirror handle CSS*	<b>210.00D</b> <b>212.00D</b>
		Inox mirror handle EU stem	<b>210.00</b>
		Inox hexagonal mirror handle	<b>13313</b>
		Inox millimeter mirror handle	<b>210.01</b>
		Rotating holder for photographic mirrors	<b>MZP214.</b>
		Sterilization tray for photographic mirrors for 3 photographic mirrors or 2 photographic mirrors + 1 handle (sold empty)	<b>233.19</b>
		Anti-mist solution for mirrors 100ml Anti-mist solution for mirrors 30ml	<b>ABF</b> <b>AB30</b>

\* USA, Canada, Spain, South Korea

Class I professional dental medical devices - CE - Manufacturer: PRODONT HOLLIGER ACTEON® Group - France

# DIAGNOSTIC INSTRUMENTS

.....

Instruments examination sets	182
Tweezers	183
Probes	184



## Instrument examination sets



**XLstyle**  
handle

### Examination set XLStyle handle

1x XL Style handle + 1x n.4 mirror, 1x probe,  
1x COLLEGE tweezers

**500.00XL.**



**Design**  
handle

### Examination set Design handle

1x Design handle + 1x n.4 mirror, 1x probe,  
1x COLLEGE tweezers

**500.00D.**



**XLstyle**  
handle

### Care set XLStyle handle

1x XL Style handle + 1x n.4 mirror,  
1x H.E.I. n°1 spatula, 1x probe,  
1x COLLEGE tweezers

**501.00XL.**



**Design**  
handle

### Care set Design handle

1x Design handle + 1x n.4 mirror,  
1x H.E.I. n°1 spatula, 1x probe, 1 COLLEGE  
tweezers

**501.00D.**

## Tweezers



**COLLEGE tweezers - 15cm angulated**

**219.01**



**COLLEGE tweezers - 15cm contra-angulated**

**219.02**



**COLLEGE tweezers - 15 cm smooth**

**220.02.**



**COLLEGE tweezers - 15 cm satiny**

**220.02S.**



**PERRY tweezers n.2 - 13cm serrated**

**222.02**



**PERRY tweezers n.3 - 13cm serrated**

**222.03**



**MERIAM tweezers - 16cm**

**227.00**



**FLAGG tweezers - 16cm**

**223.00**



**Self-locking tweezers - 15cm smooth**

**227.02**



**Self-locking tweezers - 15cm smooth with notching**

**227.04**

## Probes



**Simple probe n.6** - XLStyle handle (picture)  
Simple probe n.6 - Design handle

**262.06XL**  
**262.06D**



**Simple probe n.7** - XLStyle handle (picture)  
Simple probe n.7 - Design handle

**262.07XL**  
**262.07D**



**Simple probe n.8** - XLStyle handle (picture)  
Simple probe n.8 - Design handle

**262.08XL**  
**262.08D**



**Simple probe n.9** - XLStyle handle (picture)  
Simple probe n.9 - Design handle

**262.09XL**  
**262.09D**



**Simple probe n.17** - XLStyle handle (picture)  
Simple probe n.17 - Design handle

**262.17XL**  
**262.17D**



**Simple probe n.20** - XLStyle handle (picture)  
Simple probe n.20 - Design handle

**262.20XL**  
**262.20D**



**Simple probe n.23** - XLStyle handle (picture)  
Simple probe n.23 - Design handle

**262.23XL**  
**262.23D**



**RHEIN Simple probe** - XLStyle handle (picture)  
RHEIN Simple probe - Design handle

**266.03XL**  
**266.03D**

The instruments presented above correspond to the XL Style handle version



**Special simple probe n.5** - Design handle

**262.05D**



**Special simple probe fine end n.24** - Design handle

**262.24D**



**Double probe n.5** - XLStyle handle

**263.05XL**  
**263.05D**



**Double probe n.5** - Design handle

**263.07D**

Class I professional dental medical devices - CE - Manufacturer: PRODONT HOLLIGER ACTEON® Group - France











# RESTORATION INSTRUMENTS

.....

Sealing spatulas & modelling	188
Amalgam & composite instruments	189
GingiProtect®	190
Gingival retraction & burnisher instruments	191
Cement spatulas	191



## Sealing spatulas & modelling

	<b>WHITE (W.H.E) n.4</b> - Design handle	<b>204.04D</b>
	<b>WILLIAM DIRIGO (W.D) n.4</b> - Design handle	<b>205.04D</b>
	<b>Special (L.S.P.) n.5 ZRN*</b> - XLStyle handle (picture) <b>Special (L.S.P.) n.5 ZRN*</b> - Design handle	<b>208.05TXL</b> <b>208.05TD</b>
	<b>Special (L.S.P.) n.6</b> - XLStyle handle (picture) <b>Special (L.S.P.) n.6</b> - Design handle	<b>208.06XL</b> <b>208.06D</b>
	<b>Proximal surface composite</b> - Design handle	<b>199.00D</b>
	<b>HEIDEMANN (H.E.I.) n.1</b> - XLStyle handle (picture) <b>HEIDEMANN (H.E.I.) n.1</b> - Design handle	<b>193.01XL</b> <b>193.01D</b>
	<b>HEIDEMANN (H.E.I.) n.2</b> - XLStyle handle (picture) <b>HEIDEMANN (H.E.I.) n.2</b> - Design handle	<b>193.02XL</b> <b>193.02D</b>
	<b>HEIDEMANN (H.E.I.) n.1 ZRN*</b> - XLStyle handle (picture) <b>HEIDEMANN (H.E.I.) n.1 ZRN*</b> - Design handle	<b>193.01TXL</b> <b>193.01TD</b>
	<b>HEIDEMANN (H.E.I.) n.2 ZRN*</b> - XLStyle handle (picture) <b>HEIDEMANN (H.E.I.) n.2 ZRN*</b> - Design handle	<b>193.02TXL</b> <b>193.02TD</b>

\* Titanium Nitride Coated

Class I professional dental medical devices - CE - Manufacturer: PRODONT HOLLIGER ACTEON® Group - France

## Amalgam & composite instruments

	<b>Amalgam double instrument BOYD WALLIS (B.W.) n.4</b> Design handle	<b>206.04D</b>
	<b>Amalgam double instrument WESCOTT n.22</b> Design handle	<b>201.22D</b>
	<b>Amalgam double instrument JLM 6 ED</b> - Design handle	<b>259.06D</b>
	<b>Amalgam double instrument F.O.C.</b> serrated double plugger - Design handle	<b>173.01D</b>
	<b>Amalgam double instrument F.O.C.</b> smooth double plugger - Design handle	<b>173.04D</b>
	<b>Composite instrument ROMEROWSKI</b> double plugger - XLStyle handle	<b>404.04XL</b>
	<b>Composite instrument HOLLEMBACK 1/2-3</b> double plugger - Design handle	<b>191.04D</b>
	<b>Composite instrument UWD / DISCOÏD CLEOÏD</b> double plugger - Design handle	<b>186.05D</b>

Class I professional dental medical devices - CE - Manufacturer: PRODONT HOLLIGER ACTEON® Group - France

# gingiprotect

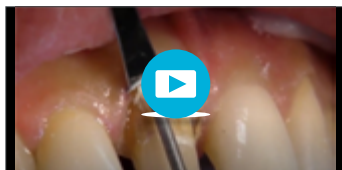

GingiProtect® video



## GINGIVAL RETRACTION INSTRUMENTS

- Effective protection and retraction of the marginal gum
- Direct and precise access to the margins



GingiProtect® double instrument - \*L 3.2mm

261GPR2



GingiProtect® double instrument - \*L 3.7mm

261GPR3



GingiProtect® double instrument - \*L 4.3mm

261GPR4

## Gingival retraction & burnisher instruments

Double instrument for gingival retraction with saw edge  
Design handle

154.02D



Temporary cavity bottom instrument - Design handle

170.01D

Double burnisher n.15 - XLStyle handle (picture)  
Double burnisher n.15 - Design handle108.15XL  
108.15D

DARBY-PERRY double excavator - Design handle

162.00D



ASH double excavator - Design handle

164.16D

## Cement spatulas

Double cement spatula n.1 - XL handle (picture)  
Double cement spatula n.1 - Design handle252.01XL  
252.01DSimple cement spatula n.18 ultra flexible  
XLStyle handle (picture)  
Design handle246.18XL  
246.18D

Simple cement spatula n.24 - XLStyle handle

248.24XL



Simple cement spatula n.36 - Design handle

250.36D



# PROSTHESIS INSTRUMENTS

.....

<b>Impression trays n.1</b>	<b>194</b>
<b>Impression trays n.2</b>	<b>194</b>
<b>Half-impression trays</b>	<b>195</b>
<b>Other prosthesis instruments</b>	<b>195</b>



## Impression trays n.1 - Thin straight edges

### UPPER

### LOWER

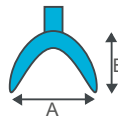
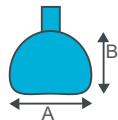

STANDARD SIZE 1 61x47mm	3040.U1	STANDARD SIZE 1 55x47mm	3040.L1
STANDARD SIZE 2 64x51mm	3040.U2	STANDARD SIZE 2 60x49mm	3040.L2
STANDARD SIZE 3 66x53mm	3040.U3	STANDARD SIZE 3 72x54mm	3040.L3
STANDARD SIZE 4 69x57mm	3040.U4	STANDARD SIZE 4 75x57mm	3040.L4
STANDARD SIZE 5 71x60mm	3040.U5	STANDARD SIZE 5 76x59mm	3040.L5
STANDARD SIZE 6 73x62mm	3040.U6	STANDARD SIZE 6 78x61mm	3040.L6

## Impression trays n.2 - Retentive edges

### UPPER

### LOWER

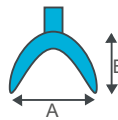
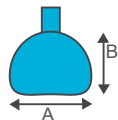

STANDARD SIZE 1 61x47mm	3041.U1	STANDARD SIZE 1 55x47mm	3041.L1
STANDARD SIZE 2 64x51mm	3041.U2	STANDARD SIZE 2 60x49mm	3041.L2
STANDARD SIZE 3 66x53mm	3041.U3	STANDARD SIZE 3 72x54mm	3041.L3
STANDARD SIZE 4 69x57mm	3041.U4	STANDARD SIZE 4 75x57mm	3041.L4
STANDARD SIZE 5 71x60mm	3041.U5	STANDARD SIZE 5 76x59mm	3041.L5
STANDARD SIZE 6 73x62mm	3041.U6	STANDARD SIZE 6 78x61mm	3041.L6

## Half impression trays

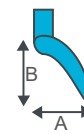

3040.L6D

Half impression tray  
Upper right  
pierced - 39x61mm



3040.L6S

Half impression tray  
Lower left  
pierced - 39x61mm

## Other instruments

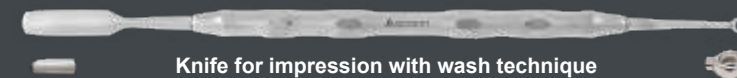

Knife for impression with wash technique  
Design handle

453.00D



Crown remover

105.00



Crown setter

3087.00



Tweezers for articulating paper

433.00

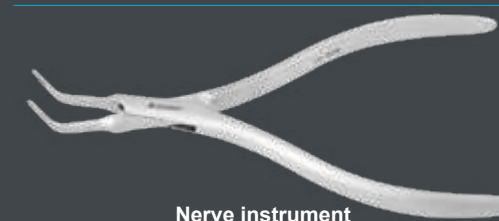

Nerve instrument

751.00



FURRER plier

897.00

# PERIODONTIC INSTRUMENTS

.....

<b>Scalers</b>	<b>198</b>
<b>Graduated probes</b>	<b>199</b>
<b>Dr Roos periosteal elevator</b>	<b>199</b>



## Scalers



**Double scaler M23** - XLStyle handle

**404.23XL**



**Double scaler CRANE KAPLAN CK6** - XLStyle handle

**404.06XL**



**Double scaler CRANE KAPLAN mini CK6**  
XLStyle handle

**404.08XL**



**Double scaler CRANE KAPLAN micro CK6 curved**  
posterior area scaling - XLStyle handle

**404.05XL**



**Simple scaler I.N.A. n.1** - Design handle

**183.01D**



**Simple scaler I.N.A. n.33** - Design handle

**183.33D**



**Double sharp instrument KIRKLAND 15/16**  
XLStyle handle

**411.15XL**

## Graduated probes



**Graduated curved probe** - laser marker 3/6/9mm  
XLStyle handle

**418.02XL**

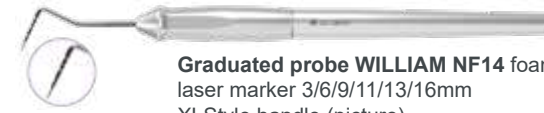

**Graduated probe WILLIAM NF14** foam tip  
laser marker 3/6/9/11/13/16mm  
XLStyle handle (picture)  
Design handle

**418.00XL**  
**418.00D**



**Graduated probe WILLIAM NF14** foam tip  
laser marker 3/6/9mm - Design handle

**418.01D**



**Graduated probe** - rounded tip - XLStyle handle (picture)  
**Graduated probe** - rounded tip - Design handle

**271.00XL**  
**271.00D**

## Dr Roos periosteal elevator

**3 IN 1 - ALL THE ADVANTAGES OF AN ELEVATOR, A RETRACTOR AND THE VISION OF AN EXCELLENT MIRROR!**

- Retract soft tissues with osseous support
- The integrated mirror allows precise visual control of the surgical act during its realization



L 4mm

**Dr Roos periosteal elevator**  
XLStyle handle

**407.05XL.**

# ENDOSURGERY INSTRUMENTS

.....

<b>Endosurgery Range</b>	<b>202</b>
<b>Endosurgery kits</b>	<b>204</b>
<b>Endosurgery instruments</b>	<b>205</b>



# endosurgery

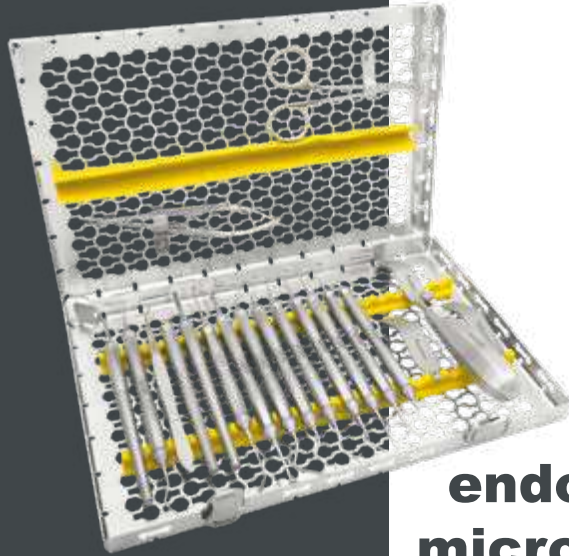

## Approaching endodontic apical micro-surgery with procedure-specific instruments

In today's world of minimally invasive solutions, the goal of dental treatment is to save the tooth before considering the extraction.

Manual instruments have a key role to play in endodontic micro-surgery; they need to fit the anatomical constraints of surgical sites in order to increase the chances of success of root canal retrofilling.

The Endosurgery Kit meets these requirements thanks to the well-adjusted instruments and micro-mirrors, providing clear and true image reflection and offering the benefits of the best optical chain from the microscope to the micro-mirror.

- 100% designed for apical micro-surgery
- Saving the tooth or the prosthetic reconstruction work
- Developed with 2 exclusive endodontists
- The best optical chain pre- & post-operative X-ray, Pure Reflect®

# endosurgery essential



### CHOOSING WHAT IS ESSENTIAL

- For practitioners who already have a standard surgery kit, we have gathered in one kit the 11 new instruments that are essential for apical endodontic microsurgery
- Finely adjusted instruments with adapted angulations to work in small cavities

# endosurgery integral



### CHOOSE A COMPLETE KIT DEPENDING ON YOUR LEVEL OF EQUIPEMENT

- The Integral Endosurgery Kit includes all the instruments of the Essential Endosurgery Kit, plus the standard surgery instruments
- Complete, ready-to-use kit compliant with the endodontic surgical protocol

## Endosurgery kits

### EndoSurgery Essential kit - 11 instruments



- Mini-blade holder
- Flap retractor
- Dual probe (periodontal probe and n.17 explorer)
- Lucas curette
- Inflammatory tissue curette n.1 and n.2
- Pure Reflect® micromirror Ø3mm
- Pure Reflect® micromirror 7x2mm - rectangular
- Micro mirror dual handle
- Filling material spatula
- Dual endo-plugger
- Dual plugger / burnisher instrument and mini-excavator

230XL

### EndoSurgery Integral kit - 17 instruments



- Mini-blade holder
- Flap retractor
- Dual probe (periodontal probe and n.17 explorer)
- Lucas curette
- Inflammatory tissue curette n.1 and n.2
- Pure Reflect® micromirror Ø3mm
- Pure Reflect® micromirror 7x2mm - rectangular
- Micro mirror dual handle
- Filling material spatula
- Dual endo-plugger
- Dual plugger / burnisher instrument and mini-excavator
- Blade holder
- XL handle + Mirror Pure Reflect® n.4
- Castroviejo needle holder with tungsten carbide jaws
- Lagrange scissors with tungsten carbide jaws
- 3-blade retractor kit
- Perry tweezers

231XL

## Endosurgery instruments



**Surgical cassette** (without instrument)  
285x192x37 mm + 2 clips for scissors and  
needle-holder

233.20



**Mini-blade holder** - XLStyle handle

610.01XL



**Flap retractor** - XLStyle handle

407.16XL



**Dual probe** (periodontal probe + N°17 explorer)  
XLStyle handle

263.18XL



**Lucas curette** - XLStyle handle

135.87XL



**Inflammatory tissue curette n.1** - XLStyle handle

412.07XL



**Inflammatory tissue curette n.2** - XLStyle handle

412.13XL

## Endosurgery instruments



Pure Reflect® micromirror Ø3mm - round

**MP3303PH**



Pure Reflect® micromirror 7x2mm - rectangular

**MP3306RPH**



Micromirror XLStyle Dual handle

**210.02XL**



Filling material spatula - XLStyle handle

**193.10XL**



Dual endo-plugger - XLStyle handle

**230.00XL**



Dual plugger / burnisher instrument - XLStyle handle

**230.01XL**



Mini excavator - XLStyle handle

**164.19XL**



Blade holder - XLStyle handle

**610.00XL**



XLStyle handle + Pure Reflect® mirror n.4

**210.36XL**



CASTROVIEJO needle holder

**747.02TC**



LAGRANGE scissors

**636.00TC**



3-blades retractor kit

**151.K**



PERRY tweezers

**222.02**



# EXTRACTION INSTRUMENTS

.....

<b>Dr Bernard syndesmotomes</b>	<b>210</b>
Syndesmotomes	211
<b>Removal blades elevators</b>	<b>212</b>
Elevators luxators	212
<b>Elevators</b>	<b>213</b>
Kopp elevators	214
<b>Other elevators</b>	<b>215</b>
Forceps super-grip beak (adult)	216
<b>Syndesmotome forceps (adult)</b>	<b>220</b>
Standard forceps (child)	221
<b>Curettes</b>	<b>222</b>



## Dr Bernard syndesmotomes

### STANDARD BLADE

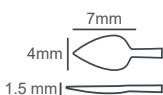











### FINE BLADE



Non removable blades



Dr. Bernard handle for removable blades

	Standard non removable blade n.0 Standard removable blade n.0	237.00 235.00
	Standard non removable blade n.1 Standard removable blade n.1 Fine removable blade n.1	237.01 235.01 235.21
	Standard removable blade n.2 Fine removable blade n.2	235.02 235.22
	Standard removable blade n.3 Fine removable blade n.3	235.03 235.23
	Standard removable blade n.4 Fine removable blade n.4	235.04 235.24
	Standard non removable blade n.5 Standard removable blade n.5 Fine removable blade n.5	237.05 235.05 235.25
	Standard removable blade n.6 Fine removable blade n.6	235.06 235.26
	Standard removable blade n.7 Fine removable blade n.7	235.07 235.27
	Standard removable blade n.8 Fine removable blade n.8	235.08 235.28
	Standard removable blade n.9 Fine removable blade n.9	235.09 235.29
	Standard non removable blade n.11 Standard removable blade n.11	237.11 235.11

## Syndesmotomes



Dr Bernard syndesmotomes kit  
with 2 handles, 9 removable fine blades,  
11 standard removable blades

241.02

Aluminium box (empty)

242.00



CHOMPRET syndesmotome straight blade n.1  
plain handle

264.01



CHOMPRET syndesmotome straight blade n.2  
plain handle

264.02



CHOMPRET syndesmotome sickle blade n.3  
plain handle

264.03



CHOMPRET syndesmotome for wisdom teeth n.4  
plain handle

264.04



Periotome syndesmotome straight, fine  
and flexible blade (wide 1mm) - plain handle

264.10



Periotome syndesmotome straight, fine  
and flexible blade (wide 2mm) - plain handle

264.11



Periotome syndesmotome curved, fine  
and flexible blade (wide 1mm) - plain handle

264.12

## Removal blades elevator



Ergonomic light handle for removable blades

159.M



Removable blade n.52

159.52F



Removable blade n.54

159.54F



Removable blade n.55

159.55F



Removable blade n.56

159.56F



Removable blade n.60

159.60F

1 handle + 5 removable blades

159.K

## Elevators luxators



Elevator luxator curved 3mm

159.3C



Elevator luxator straight 3mm

159.3D



Elevator luxator curved 5mm

159.5C



Elevator luxator straight 5mm

159.5D

## Elevators



STANDARD HANDLE



2.5mm

156.50



White Apical 3mm

156.63



2.5mm

156.51



White Apical 3mm

156.65



3mm

156.52



Bein 3mm

156.66



Bein 5mm

156.53



Bein 4mm

156.67



4mm

156.55



Roy 3mm

156.69



5mm

156.57



Heidbrink apex 2mm

156.76



3mm

156.60



Heidbrink apex 2mm

156.77



3.5mm

156.61



Heidbrink apex 2mm

156.78

## Kopp elevators



The Kopp elevators have a sharp edged helical groove that follows the root tip down and around cutting the ligament. there is a natural cutting action as the elevator moves apically.

**Perfect for rotating around the root.**



**Kopp elevator left oriented**

**156.40**



**Kopp elevator right oriented**

**156.41**

## Other elevators



**Elevator ergonomic handle**

**159.79**



**COUPLAND elevator**

**156.84**



**COUPLAND elevator**

**156.86**



**VIGNAL bayonet elevator**

**149.01**



# Forceps super-grip beak (adult)

## Upper

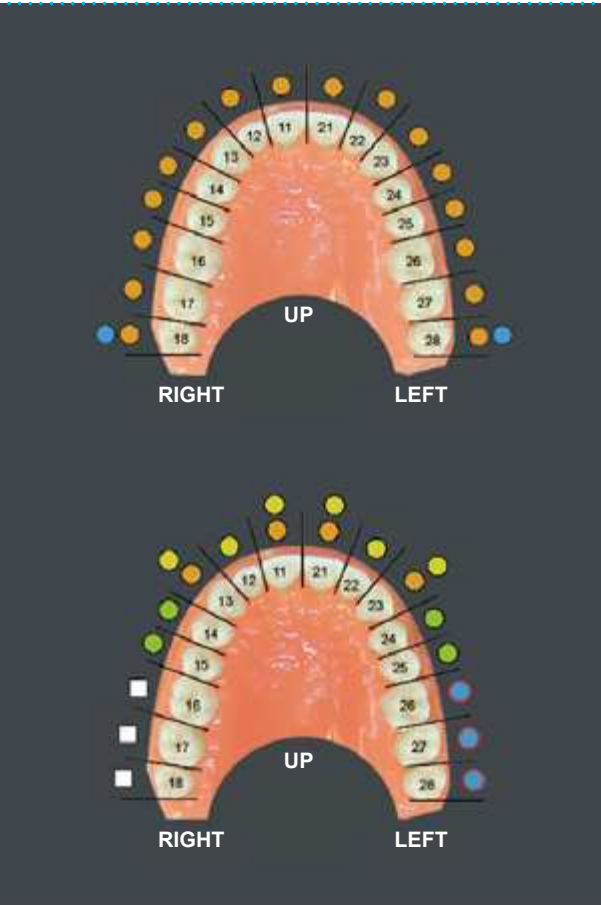

290.02 Incisors & canines

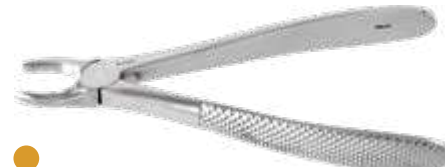

290.01 Central incisors & canines



290.51 Roots



291.51 Roots



291.60 Extra slim jaws Roots



291.61 Short, extra slim jaws Roots



291.62 Extra slim jaws Roots



290.07 Bicuspids



290.17 Right molars



290.18 Left molars

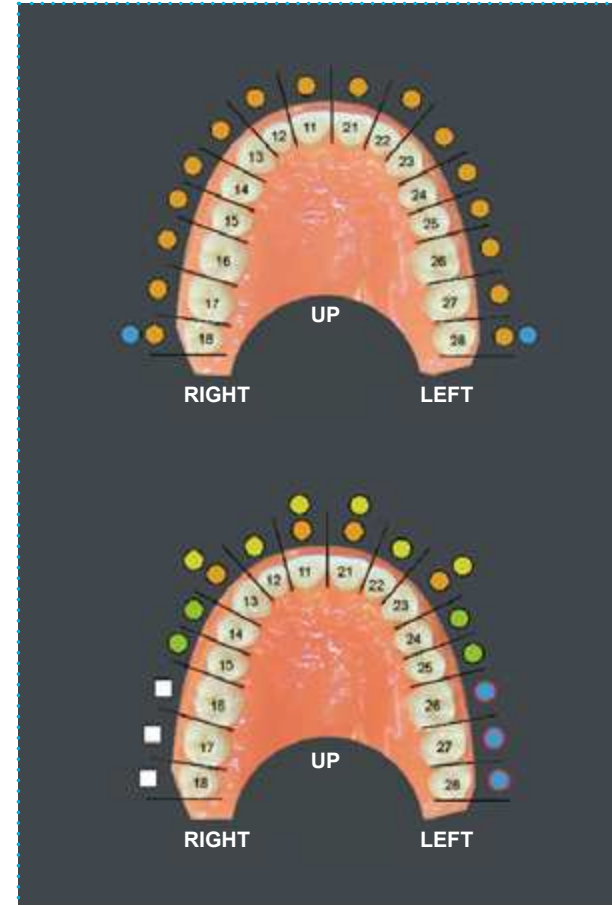

291.67 Wisdoms

# Forceps super-grip beak (adult)

Lower



REF. 290.04 Incisors & canines



REF. 291.74 Roots & Incisors

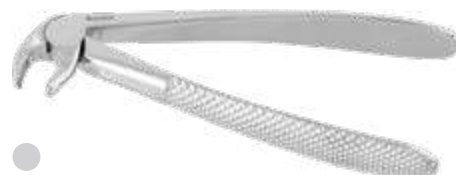

REF. 290.13 Canines & premolars



REF. 290.75 Canines & premolars



REF. 290.08 Premolars

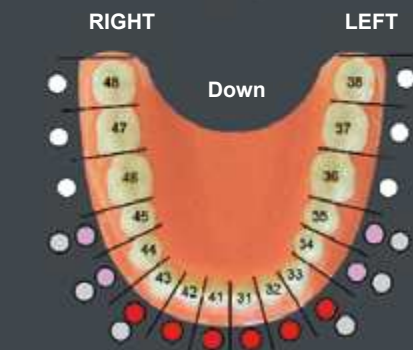
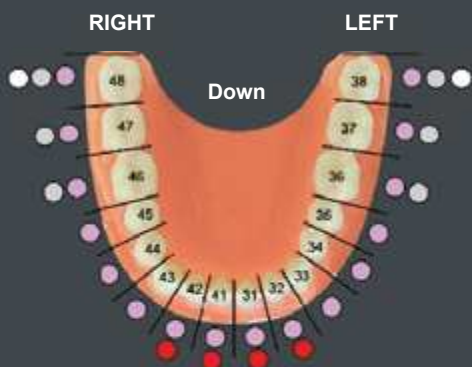

REF. 290.33 Roots



REF. 291.86 Decayed Molars or with broken crown



REF. 290.21 Molars



REF. 290.79 Wisdoms



REF. 290.22 Molars

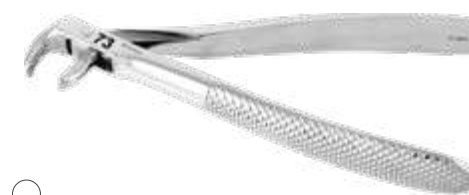

REF. 290.73 Molars

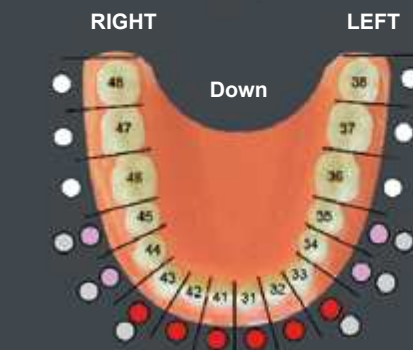
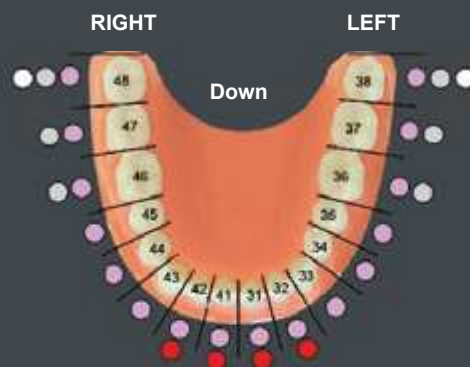

## Syndesmotome forceps (adult)



Lower roots

290.23



Upper

290.24



Lower

290.25

## Standard forceps (child)



Lower - Premolars

291.13



Lower - Molars

291.22



Lower - Roots

291.33



Lower - Incisors & Canines

291.38



Upper - Roots

291.29



Upper - Incisors









291.37











Upper - Molars

291.39

## Curettes

	<b>CHOMPRET curette n.1</b> - XLStyle handle	<b>134.01XL</b>
	<b>CHOMPRET curette n.2</b> - XLStyle handle	<b>134.02XL</b>
	<b>CHOMPRET curette n.3</b> - XLStyle handle	<b>134.03XL</b>
	<b>CHOMPRET curette n.4</b> - XLStyle handle	<b>134.04XL</b>
	<b>CHOMPRET curette n.5</b> - XLStyle handle	<b>134.05XL</b>
	<b>Granulation curette n.1</b> - XLStyle handle	<b>131.01XL</b>
	<b>Granulation curette n.2</b> - XLStyle handle	<b>131.02XL</b>
	<b>Granulation curette n.3</b> - XLStyle handle	<b>131.03XL</b>
	<b>LUER FRIEDMAN plier</b> fine jaws, 13cm	<b>591.00</b>

	<b>HEMINGWAY curette n.0</b> - XLStyle handle	<b>135.00XL</b>
	<b>HEMINGWAY curette n.0</b> - Design handle	<b>135.00D</b>
	<b>HEMINGWAY curette n.1</b> - XLStyle handle	<b>135.01XL</b>
	<b>HEMINGWAY curette n.1</b> - Design handle	<b>135.01D</b>
	<b>HEMINGWAY curette n.2</b> - XLStyle handle	<b>135.02XL</b>
	<b>HEMINGWAY curette n.2</b> - Design handle	<b>135.02D</b>
	<b>HEMINGWAY curette n.3</b> - XLStyle handle	<b>135.03XL</b>
	<b>HEMINGWAY curette n.3</b> - Design handle	<b>135.03D</b>
	<b>LUCAS curette n.85</b> - XLStyle handle	<b>135.85XL</b>
	<b>LUCAS curette n.85</b> - Design handle	<b>135.85D</b>
	<b>LUCAS curette n.86</b> - XLStyle handle	<b>135.86XL</b>
	<b>LUCAS curette n.86</b> - Design handle	<b>135.86D</b>

The instruments presented above correspond to the XL Style handle version



# SURGERY INSTRUMENTS

.....

<b>Goldman Fox scissors</b>	<b>226</b>
<b>Metzenbaum scissors</b>	<b>227</b>
<b>Scissors</b>	<b>227</b>
<b>Tweezers</b>	<b>228</b>
<b>Forceps</b>	<b>229</b>
<b>Needle-holders</b>	<b>230</b>
<b>Scalpels</b>	<b>231</b>



## Goldman Fox scissors



Gum scissors curved - 11cm

620.01



GOLDMAN FOX scissors  
curved, fine and sharp - 10.5cm

622.00



GOLDMAN FOX scissors TC\*  
curved, fine and sharp - 10.5cm

622.00TC.



GOLDMAN FOX scissors  
straight, fine and sharp - 10.5cm

621.00



GOLDMAN FOX scissors TC\*  
straight, fine and sharp - 10.5cm

621.00TC.



GOLDMAN FOX scissors  
straight, micro - 9cm

623.00



GOLDMAN FOX scissors  
straight, sharp - 11cm

625.00



GOLDMAN FOX scissors  
curved, sharp - 9cm

624.00

\* Tungsten carbide

Class I professional dental medical devices - CE - Manufacturer: PRODONT HOLLIGER ACTEON® Group - France

## Metzenbaum scissors



METZENBAUM scissors TC\*  
straight - 14cm

651.00TC



METZENBAUM scissors  
curved - 14cm

652.00



METZENBAUM scissors TC\*  
curved - 14cm

652.00TC

## Scissors



Scissors straight, sharp - 13cm

654.00.



Scissors curved, sharp - 13cm

655.00



LAGRANGE scissors TC\* - 11.5cm

636.00TC



CASTROVIEJO scissors TC\*  
Curved - 12cm

647.02TC

\* Tungsten carbide

Class I professional dental medical devices - CE - Manufacturer: PRODONT HOLLIGER ACTEON® Group - France

## Tweezers



Tissue tweezers straight - 14cm

222.07



Tissue tweezers straight, serrated jaws - 14cm

222.06



Tissue tweezers straight, serrated jaws - 18cm

222.09



Tissue tweezers flat jaws  
Tissue or membrane graft - 12cm

222.13.



ADSON surgical tweezers with notching - 12.5cm

222.10



ADSON surgical tweezers - 12cm

222.11



ADSON surgical tweezers smooth - 12.5cm

222.12



Suture tweezers corn - 15cm

432.00

## Forceps



Backhaus field forceps - 9cm

707.00



Backhaus field forceps - 11cm

708.00



LUER FRIEDMAN plier  
fine jaws, 13cm

591.00



MOSQUITO haemostatic forceps  
curved - 12cm

724.01

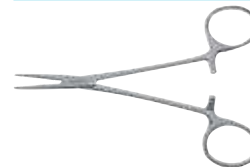

HALSTEAD-MOSQUITO  
Haemostatic forceps, straight - 12cm

723.00



HALSTEAD-MOSQUITO  
Haemostatic forceps, curved - 12cm

724.00



HALSTEAD-MOSQUITO  
Haemostatic forceps, curved - 12cm

726.00

## Forceps



**CRILLE haemostatic forceps straight** - 14cm

**729.00**



**CRILLE haemostatic forceps curved** - 14cm

**730.00**



**PEAN haemostatic forceps straight** - 13cm

**713.00**

## Needle-holders



**MATHIEU needle-holder TC\*** - 14cm

**743.00TC**



**MATHIEU needle-holder** - 14cm

**743.00**



**CASTROVIEJO needle-holder straight TC\*** - 15cm

**747.01TC**



**CASTROVIEJO needle-holder curved TC\*** - 15cm

**747.02TC**



**CRILLE WOOD needle-holder TC\***  
16cm

**748.00TC**

\* Tungsten carbide

Class I professional dental medical devices - CE - Manufacturer: PRODONT HOLLIGER ACTEON® Group - France

## Scalpels



**n.4 BARD PARKER scalpel handle**  
for disposable sterile blade with plastic shield safety lock

**600.04**



**Sterile blade n.23 x1**  
for n.4 Bard Parker handle

**615.23**



**XLStyle blade holder** for easy grip and roll

**610.00XL**



**Economic standard handle**

**601.03**



**Sterile blade n.11 x100**

**615.11**



**Sterile blade n.15 x100**

**615.15**

Class I professional dental medical devices - CE - Manufacturer: PRODONT HOLLIGER ACTEON® Group - France



# IMPLANTOLOGY INSTRUMENTS

.....

<b>Angulated convex osteotomes</b>	<b>234</b>
<b>Angulated concave osteotomes</b>	<b>235</b>
<b>Stop &amp; assembly tool</b>	<b>236</b>
<b>Implantology cassette</b>	<b>236</b>
<b>Retractors</b>	<b>237</b>
<b>Scissors</b>	<b>238</b>
<b>Needle-holders</b>	<b>238</b>
<b>Mallet</b>	<b>239</b>
<b>Bone curette</b>	<b>239</b>
<b>Pilars instrument</b>	<b>239</b>
<b>Dr Roos periosteal elevator</b>	<b>240</b>
<b>Elevators</b>	<b>240</b>
<b>Surgical tweezers</b>	<b>241</b>
<b>Implant Remover kit</b>	<b>242</b>



## Angulated convex osteotomes



Osteotome angulated convex - 2.7mm

350.01.



Osteotome angulated convex - 3.2mm

350.02.



Osteotome angulated convex - 3.7mm

350.03.



Osteotome angulated convex - 4.2mm

350.04.



Osteotome angulated convex - 5mm

350.05.



**Set of 5 angulated convex osteotomes**

Included: tray  
Non included: stops and assembly tools

350.11



**Set of 6 angulated conic convex osteotomes**

Included: tray  
Non included: stops and assembly tools

352.11

## Angulated concave osteotomes



Osteotome angulated concave - 2.7mm

351.01.



Osteotome angulated concave - 3.2mm

351.02.



Osteotome angulated concave - 3.7mm

351.03.



Osteotome angulated concave - 4.2mm

351.04.



Osteotome angulated concave - 5mm

351.05.



**Set of 5 angulated concave osteotomes**

Included: tray  
Non included: stops and assembly tools

351.11

## Stop & assembly tool



Stop for osteotome - 2.3mm

200.00



Stop for osteotome - 2.7mm

200.11



Stop for osteotome - 3.2mm

200.12



Stop for osteotome - 3.7mm

200.13



Stop for osteotome - 4.2mm

200.14



Stop for osteotome - 5mm

200.15



Assembly tool

200.20

## Implantology cassette

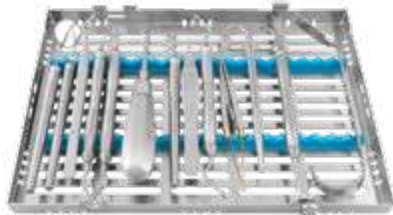

Implantology cassette

360XL

- Mirror handle
- Colledge satin tweezers
- Adson tweezers
- n°6 Probe
- CK6 scaler
- Hemingway bone curette
- Scalpel handle
- H.E.I. N°1 spatula
- Bone spoon
- Castroviejo needle-holder
- straight jaws
- Joseph scissors
- Contraangulated retractors
- Luxator elevator
- Sterilization tray

## Retractors



FARABOEUF retractors - 12cm - x2

151.00



Contra-angled retractor

151.03



DAUTREY retractor - 13cm

151.02



DAUTREY retractor - 14cm

151.01

## Scissors



**LAGRANGE scissors TC\*** - 11.5cm

**636.00TC**



**CASTROVIEJO scissors TC\***  
Curved - 12cm

**647.02TC**



**METZENBAUM scissors TC\***  
straight - 14cm

**651.00TC**



**METZENBAUM scissors TC\***  
curved - 14cm

**652.00TC**

## Needle-holders



**CASTROVIEJO needle-holder TC\***  
straight - 15cm

**747.01TC**



**CASTROVIEJO needle-holder TC\***  
curved - 15cm

**747.02TC**

\* Tungsten carbide

## Mallet



**POLITZER teflon mallet** - 18cm - 150g

**213.02**

## Bone curette



**Drs Aubazac bone curette** - XL Style handle

**407.10XL**

## Pilars instrument



**Pilars instrument** - Design handle

**206.10D**



## Dr Roos periosteal elevator

### 3 IN 1 - ALL THE ADVANTAGES OF AN ELEVATOR, A RETRACTOR AND THE VISION OF AN EXCELLENT MIRROR!

- Retract soft tissues with osseous support
- The integrated mirror allows precise visual control of the surgical act during its realization



L 4mm

**Dr Roos periosteal elevator**  
XLStyle handle

**407.05XL.**

## Elevators



**BUD mini-elevator** - 2-3mm - XLStyle handle

**407.12XL**

**MOLT elevator n.7** - 4.5-3.5mm - XLStyle handle (picture)  
**MOLT elevator n.7** - 4.5-3.5mm - Design handle

**407.07XL**  
**407.07D**

**MOLT elevator n.8** - 5.5-4mm - XLStyle handle (picture)  
**MOLT elevator n.8** - 5.5-4mm - Design handle

**407.08XL**  
**407.08D**

**MOLT elevator n.9** - 7-5mm - XLStyle handle (picture)  
**MOLT elevator n.9** - 7-5mm - Design handle

**407.09XL**  
**407.09D**

**BENQUE elevator** - Design handle - 4-6.5mm

**407.01D**

**PRITCHARD elevator** - 4.4-12mm - XLStyle handle (picture)  
**PRITCHARD elevator** - 4.4-12mm - Design handle

**407.03XL**  
**407.03D**

**HOURIGAN elevator** - 4-4.3mm - XLStyle handle

**407.04XL**

## Surgical tweezers



**Tissue tweezers flat jaws** - tissue or membrane graft

**222.13.**

**ADSON surgical tweezers with notching** - 12.5cm

**222.10**

**ADSON surgical tweezers** - 12cm

**222.11**

**ADSON surgical tweezers smooth** - 12.5cm

**222.12**

# implant remover



## Screw and implant extraction kit

- Less traumatizing in implant surgery, they minimize the osseous losses by avoiding bone drilling and surgery during the extraction of an implant.
- Both left and right extractors are screwed and unscrewed alternatively into the implant to gradually separate it from the bone.

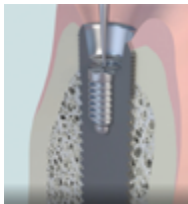
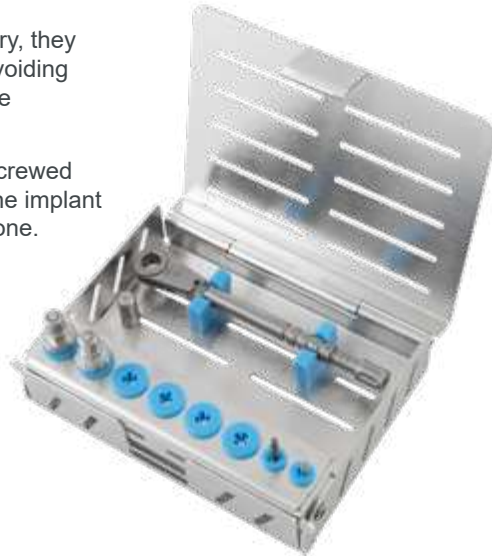

### SCREW EXTRACTION

Broken screw removal may be caused by:  
Excessive tightening force  
Wear



### IMPLANT EXTRACTION

Complications that may require an implant removal:

- No osteointegration / loss of osteointegration
- Positional anomalie of the implant
- Periimplantitis generating a bone loss



**Implant remover kit - long extractors**  
with 1 sterilization tray, 1 key,  
1 adapter, 1 screw extractor, 1 rounded bur  
and 2 long implant extractors

**300.24**

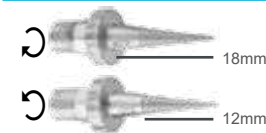

**Implant remover kit - short extractors**  
with 1 sterilization tray, 1 key,  
1 adapter, 1 screw extractor, 1 rounded bur  
and 2 short implant extractors

**300.25**

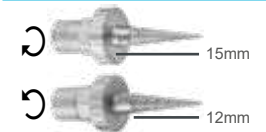

**ImplantRemover sterilization tray**  
(empty)

**300.02**

**Implant extractors** for long tooth  
Ø5mm

**300.34**

**Implant extractors** for short tooth  
Ø4mm

**300.56**



**Screw extractor**

**300.12**



**Rounded bur**

**300.11**



**Torque Ratchet Key - 10-40N/cm**

**300.01**



**Universal adapter**

**300.09**

# ORTHODONTIC INSTRUMENTS

.....

Alginate mixer

246

Pliers & orthodontic instruments

247



# Mixes all your alginates in 5 seconds without bubbles



- Ecological
- Simple
- Fast
- Hypoallergenic

**WARRANTY: 18 MONTHS**

Weight: 18kg

Dimensions: 20x24x30cm

## Alginate mixer

with 4 bowls, 1 dosing bottle, 1 spatula, 1 mixer

**3055.00**



**Bowl** for alginate mixer

**3055.01**



**Spatula** for alginate mixer

**3055.02**



**Dosing bottle** for alginate mixer

**3055.03**

## Pliers & orthodontic instruments



**MALLOTHY plier** - 12.5cm  
Wire and clasp bending pliers

**877.00**



**ANGLE plier** - 12cm

**876.00**



**ADAMS plier** - 12cm

**875.00**



**ADERER plier** - 12cm  
jaw: 0.9mm

**881.00**



**Sharp-cutting plier** - Side snippers

**832.00**



**Crown scissors** curved jaws, smooth - 9cm

**811.00**



**Crown scissors** straight jaws, smooth - 9cm

**810.00**



**Satin orthodontic tweezers**  
with flat streaked jaws for brackets

**224.01.**



**Satin orthodontic tweezers**  
with curved fine jaws for tubes

**224.02.**

# ACCESSORIES

.....

<b>Sterilization cassettes</b>	<b>250</b>
<b>Endodontic supports</b>	<b>251</b>
<b>Trays</b>	<b>251</b>
<b>Ultrasonic cleaners</b>	<b>252</b>
<b>Burners</b>	<b>253</b>



## Sterilization cassettes



**Easy clip tray (empty)**  
180x136x30mm  
8 instruments - Material: PSU 90g

233.30



**Surgical cassette (empty)**  
285x192x37mm + 2 clips for scissors and  
needle-holder

233.20



**ImplantRemover sterilization tray**  
(empty)

300.02



**Sterilization tray**  
for 3 photographic mirrors  
or 2 photographic mirrors + 1 handle  
(sold empty)

233.19



**Stainless steel tray with silicone**  
8 locations - 180x130x25mm

233.13



**Stainless steel tray with silicone**  
10 locations - 180x130x25mm

233.14

## Endodontic supports



**Green endodontic support**  
8 locations

3121.10



**Blue endodontic support**  
8 locations

3121.11

## Trays



**Tray - 20x10cm**  
Customize your trays with laser  
etching starting from 20 pcs.

233.10



**Tray - 20x15cm**  
Customize your trays with laser  
etching starting from 20 pcs.

233.15

- Hygienic Aluminum control panel
- Silent PEHD cover
- Stainless steel Structure / 2 years guarantee
- Waterproof switch



**Ultrasonics cleaner 5L**  
280x180x260mm - Usable volume 3.2L

*PH500N*

**Ultrasonics cleaner 5L - beaker**  
280x180x260mm - Usable volume 3.2L

*PH500NB*

**Ultrasonics cleaner 5L - 20-60°C**  
280x180x260mm - Usable volume 3.2L

*PH500CN*

**Ultrasonics cleaner 5L - 20-60°C - beaker**  
280x180x260mm - Usable volume 3.2L

*PH500CNB*

# protorch 4

## Mini rechargeable gas torch

### PRECISE AND ADJUSTABLE FLAME

- 25ml
- Butane
- 1h20 autonomy
- 1300°C / 2372°F



**PROTORCH 4 burner**  
20mB - 16.5th

*FU31/0404*



**MINIFLAM gas cartridge - 400ml - x10**

*FU47-1603*



**AIRHOLY® warm air burner**

*FU37/2000R*



---

# **ACTEON<sup>®</sup> PHARMA & SPECIALTY CONSUMABLES**

<b>HYGIENE &amp; DISINFECTION</b>	<b>256</b>
<b>PROSTHETICS &amp; RESTORATIVE</b>	<b>270</b>
<b>PROPHYLAXIS &amp; PERIODONTICS</b>	<b>286</b>
<b>ENDODONTICS</b>	<b>292</b>
<b>ANESTHETICS &amp; SURGERY</b>	<b>302</b>



# HYGIENE & DISINFECTION

.....

<b>RISKONTROL® Disposable tips</b>	<b>258</b>
<b>SEPTOL® Aspiration</b>	<b>264</b>
<b>SEPTOL® Rotative</b>	<b>265</b>
<b>SEPTOL® Instruments enzymatic</b>	<b>266</b>
<b>SEPTOL® Empreinte</b>	<b>267</b>
<b>SEPTOL® Savon doux</b>	<b>268</b>
<b>SEPTOL® Spray</b>	<b>269</b>



## METALLIC TIPS

## DID YOU KNOW?

It is impossible to clean correctly the inside of reusable tips due to the presence of biofilm.<sup>(1)</sup>



Metallic tip after 1 year of use

- Not effective cleaning of reusable tips in the long-term.
- Hygiene maintenance takes time between two patients.



*With regard to cleaning and sterilization, disposable tips were found to be more acceptable in clinical use than metal tips.<sup>(1)</sup>*

(1) M.Inger, V.Bennani, M.Farella, F.Bennani, RD.Cannon. Efficacy of air/water syringe tip sterilization. Australian Dental Journal 2014;59:87-92 - R. Puttaiah et al. Rationale for using single-use disposable air/water syringe tips. Compendium. 1999;20(11):1056-1069

# riskontrol

Disposable tips

## YOUR DAILY ROUTINE



- Save time & money
- Ensure your clinical protection
- Protect your patient
- Meet your expectations for your different procedures
- Easily reach difficult-to-access areas
- Avoid risk of ingestion

(2) ML Silva, M. Zumpe, J. Lespinasse, M. Aulois-Griot. Cost comparison of reusable and disposable air/water syringe tips in a large French teaching hospital. Swiss Dental Journal 2017

# universal solution

## Match with your air/water syringe

RISKONTROL® adapters are available for more than 150 types of dental chairs.

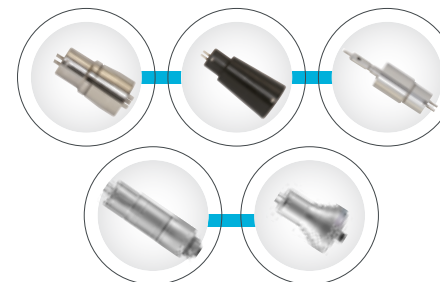

Easy to fit



(1) M.Inger, V.Bennani, M.Farella, F.Bennani, RD.Cannon. Efficacy of air/water syringe tip sterilization. Australian Dental Journal 2014;59:87-92 - R. Puttaiah et al. Rationale for using single-use disposable air/water syringe tips. Compendium. 1999;20(11):1056-1069

(2) ML Silva, M. Zumpe, J. Lespinasse, M. Aulois-Griot. Cost comparison of reusable and disposable air/water syringe tips in a large French teaching hospital. Swiss Dental Journal 2017



art  
by **riskontrol**  
Adapt your tips to the taste  
of your patients



**Non-sterile orange/mandarine tips**  
x 250

201 701



**Non-sterile grey/liquorice tips**  
x 250

201 702



**Non-sterile green/anise tips**  
x 250

201 703



**Non-sterile purple/black currant tips**  
x 250

201 704



**Non-sterile white/mint tips**  
x 250

201 700



total protec  
by **riskontrol**

Protect entirely your  
air/water syringe thanks to  
the plastic sheath



**Non-sterile white tips**  
x 100 - with plastic sheath

201 751

**Non-sterile blue tips**  
x 100 - with plastic sheath

201 750



classic  
by **riskontrol**  
Add color to your patients'  
care experience



**Non-sterile white tips**  
x 250

201 664



**Non-sterile blue tips**  
x 250

201 665



**Non-sterile yellow tips**  
x 250

201 666



**Non-sterile green tips**  
x 250

201 667



**Non-sterile pink tips**  
x 250

201 668

Class I medical devices - CE - Manufacturer: PRODUITS DENTAIRE PIERRE ROLLAND - ACTEON® Group - France



sterile  
by **riskontrol**  
Choose a totally sterile  
workflow



**Sterile disposable tips**  
x 96 - sterilized with ethylene oxide

201 770





















Class Is medical device (GMED) - CE 0459 - Manufacturer: PRODUITS DENTAIRE PIERRE ROLLAND - ACTEON® Group - France























## Adapters for air/water syringe

The Riskontrol® range includes different adapters able to equip about a large number of dental chairs.

The adapters are delivered with 1 protective cap and, depending on the types, with a replacement O-ring to ensure optimal functioning of your syringe.

Contact your area dealer to determine the correct adapter for your dental chair.

ADEC INOX (NV)  200 195	ADEC NEW (NV)  200 205
BELMONT NEW (NV)  200 158	CAS INOX (NV)  200 198
CASTELLINI LOGO NEW (NV)  200 184	CASTELLINI V (NV)  200 163
CEFLA INOX (NV)  200 197	D.C.I. (NV)  200 152
DENTALEZ (NV)  200 164	ENGLE (NV)  200 194
FA E (NV)  200 165	FA E2 (NV)  200 166
FA C (NV)  200 167	FA C2 (NV)  200 168
FA S1 (NV)  200 182	FLEX (NV)  200 169
GNATUS INOX (NV)  200 149	KAVO C (NV)  200 171
KAVO DB (NV)  200 157	KAVO E (NV)  200 172

KAVO GB (NV)  200 156	KAVO HB (NV)  200 153
KAVO IB (NV)  200 192	KAVO J (NV)  200 181
KAVO K (NV)  200 160	LU INOX (NV)  200 150
LU V (NV)  200 173	LU NEW INOX (NV)  200 199
MORITA 66  200174	MORITA 66 TYPE 2 (NV)  200 159
MORITA INOX WS10 (NV)  200 201	MORITA INOX WS97 (NV)  200 200
MORITA S12 (NV)  200 183	RITTER TOP JET (NV)  200 176
RITTER COMBIJET (NV)  200 175	SIEMENS 2000 (NV)  200 177
SIEMENS 4000 (NV)  200 178	SIRONA B (NV)  200 154
SIRONA L (NV)  200 196	TRIDAC II (NV)  200 190
YOSHIDA 3 (NV)  200 193	YOSHIDA V (NV)  200 180

**Find the adapter that matches perfectly with your equipment in our adapters guide**



Adapters guide

# septol aspiration

Cleaning and disinfection of suction systems in a dental environment.

## Microbiological properties

- Bactericidal\* according to EN 13727/EN 14561 in 15min, 1%.
- Yeasticidal\* according to EN 13624/EN 14562 in 15min, 1%.
- Tuberculocidal\* according to EN 14348/EN 14563 in 60min, 1,6%.
- Active on enveloped viruses\* according to EN 14476/EN 17111 in 15min, 2%.

## Instructions for use

Concentrated solution. Prime the associated pump before first use. Dilute at 2% (40ml for 2 litres of water). Rinse the suction system with the diluted solution and aspirate the diluted solution. To achieve efficacy, 15 minutes minimum are required. The solution can be left in the system overnight. To complete the treatment, fill the suction system with at least 1 litre of tap water and aspirate to rinse the suction system. Change the diluted solution at least once per day. Any prolonged exposure to a high temperature (> 35°C) may lead to a change in the colour without altering the antimicrobial performance. Scientific dossier (efficacy, compatibility, etc.) available on request.



### Septol™ Aspiration

5 liter-bottle with a 20cc dosing pump

268 297

\* dirt conditions

Class IIa Medical device (GMED) - CE0459 - Manufacturer: DMD - France  
Distributed by: PRODUITS DENTAIREs PIERRE ROLLAND - ACTEON® Group - France

Available for sale until stock clearance

# septol rotative

Ready-to-use, detergent disinfectant solution for the treatment of burs, rotary and canal instruments prior to sterilisation.

## Microbiological properties

- Bactericidal\* according to EN 13727/EN 14561 in 5min.
- Yeasticidal\* according to EN 13624/EN 14562 in 5min.
- Tuberculocidal\* according to EN 14348/EN 14563 in 60min.
- Active against enveloped viruses\* according to EN 14476/EN 17111 in 15min.

## Instructions for use

Ready-to-use solution. Pour Septol™ Rotative into a dip tank. Do not dilute. Totally immerse the instruments into the solution, cover and leave to soak. Comply with the minimum contact time of 5 minutes. Remove the instruments from the solution. Thoroughly rinse treated medical devices with tap water to remove all traces of product and organic soiling. Properly dry the instruments and prepare them for sterilisation. Replace the solution as soon as it is visibly soiled and at least once per day to maintain the effectiveness of the product.

Scientific dossier (efficacy, compatibility, etc.) available on request.



### Septol™ Rotative

2 liter-bottle

268 305

### Septol™ Rotative immersion tank

268 326

\* dirt conditions

Class IIb Medical device (GMED) - CE0459 - Manufacturer: Laboratoires Anios - France  
Distributed by: PRODUITS DENTAIREs PIERRE ROLLAND - ACTEON® Group - France

Available for sale until stock clearance

# septol instruments enzymatic

Cleaning and disinfection of dental instrumentation before sterilisation



## Microbiological properties

- Bactericidal\* according to EN 13727/EN 14561 in 5min, 0.5%.
- Yeastocidal\* according to EN 13624/EN 14562 in 5min, 0.5%.
- Active on enveloped viruses\* according to EN 14476/EN 17111 in 15min, 0.5%.

## Instructions for use

Concentrated solution. Use for soaking and ultra-sonic bath at a required solution, respecting the minimum contact time. Totally immerse the medical device. Keep the soaking bath covered during the contact time. Brush if visible soiling is present. Thoroughly rinse treated medical devices with tap water to remove all traces of product and organic soiling. Replace the solution as soon as it is visibly soiled and at least once per day to maintain the effectiveness of the product.

Scientific dossier (efficacy, compatibility, etc.) available on request.

### Septol™ Instruments Enzymatic

1 liter-bottle with a dosing pump

268 291

### Septol™ Instruments Enzymatic immersion tank

268 375

\* dirt conditions

Class IIb Medical device (GMED) - CE0459 - Manufacturer: Laboratoires Anios - France  
Distributed by: PRODUITS DENTAIREs PIERRE ROLLAND - ACTEON® Group - France

Available for sale until stock clearance

# septol empreinte

Concentrate disinfectant liquid for impressions



SEPTOL™ Empreintes is an aldehyde-free concentrated disinfectant with a wide range of action prepared and tested in compliance with new harmonised European disinfection regulations. SEPTOL™ Empreintes has been designed for high-level, rapid disinfection of impressions (addition and condensation), in silicone, alginate, polyether and polysulphur: the impressions remain unaltered, have no significant dimensional change and are compatible with plasters.

## Use

Immediately after taking the impression, rinse the impression under running water for 30 seconds. Inspect the impression to make sure that all visible contamination has been removed. In case of visible contamination repeat rinsing. Place the impression for 10 minutes in a 1% solution bath of SEPTOL™ Empreintes to be added to every litre of water). Remove the impression from the bath and rinse it thoroughly. Follow recommended immersion times as suggested. Replace the disinfectant solution every day, and in any case never disinfect more than 40 impressions with the same solution, in the day. Replace solutions immediately if there is visible contamination (blood, saliva or organ tissue) and/or if the colour/odour of the disinfectant solution changes, as this may interfere with its disinfectant action. Unused disinfectant solutions will remain stable for 7 days if stored in a sealed plastic container (HDPE, GPPS, ABS, PP and PMMA) away from light and heat.

## Range of action

Efficacy (microorganisms)	Reference standard	Concentration	Reaction time (minutes)
Bactericidal (S.aureus, P.aeruginosa, E.hirae)	EN 13727	1%	10
Yeastocidal (C.albicans)	EN 13624	1%	10
Tuberculocidal (M.terrae)	EN 14348	1%	10
Virucidal against enveloped viruses including HIV, HBV, HCV	EN 14476	1%	10

### Septol™ Empreintes

1 liter-bottle

268 322

### Septol™ Empreintes immersion tank

268 325

Class IIa medical device (GMED) - CE 0459 - Manufacturer: PRODUITS DENTAIREs PIERRE ROLLAND - ACTEON® Group - France

Available for sale until stock clearance

# septol savon doux

## Gentle Hand Wash

Recommended for frequent hand hygiene. pH neutral formulation enriched with moisturizing glycerine and emollients. Dermatologically tested. Suitable for sensitive skin.

### Septol™ Savon Doux

1 liter-bottle with 4ml dosing pump\*

268 507

### Septol™ Savon Doux

5 liter-bottle with tap\*

268 506

### Septol™ Savon Doux

1 liter-bottle for wall dispenser

268 510

### Metal wall dispenser

260 511

\*Accessories available separately

This product is covered by the regulation on cosmetics products

Available for sale until stock clearance



# septol spray

Disinfection of previously cleaned, nonimmersible, non-invasive, alcohol-resistant medical devices



## Microbiological properties

Ready to use solution.

- Bactericide in 5min, 20°C (EN 13727, EN 13697).
- Active against MRSA in 5min, 20°C (EN 13727).
- Yeasticide in 5min, 20°C (EN 13624, EN 13697).
- Mycobactericide in 15min, 20°C (EN 14348).
- Fungicide in 15min, 20°C (EN 13624, EN 13697).
- Active in accordance with EN 14476 in 1min, 20°C, against HIV-1, PRV (surrogate of HBV), BVDV (surrogate of HCV), Vaccinia virus, Herpesvirus.

## Instructions for use

Ready to-use solution for professional use. Use on previously cleaned medical devices (MD). Spray on the areas to be treated until they are totally moistened. Apply in sufficient quantity (6ml/m<sup>2</sup>, i.e. approx. 10 sprays). Make sure that the MD remain damp throughout the period of action. Respect the indicated contact time for the required antimicrobial activity. Thoroughly rinse the treated areas intended to come into contact with skin with tap water. For the frequency of use, refer to the hygiene plan in place. Remarks: Before application, check compatibility of the surfaces treated with alcohol. Electrical devices being disinfected must be switched off. Scientific dossier (efficacy, compatibility, etc.) available on request

### Septol™ Spray

750 ml with a foaming spray

268 301

### Septol™ Spray

5 liter-bottle with tap

268 300

Class IIa Medical device (GMED) - CE0459 - Manufacturer: Laboratoires Anios - France  
Distributed by: PRODUITS DENTAIRE PIERRE ROLLAND - ACTEON® Group - France

Available for sale until stock clearance



# PROSTHETICS & RESTORATIVE

.....

<b>EXPASYL™ / EXPASYL™ EXACT</b>	<b>272</b>
<b>CAV-hycal™</b>	<b>276</b>
<b>COOLSIN™ plus</b>	<b>276</b>
<b>PR SCELL™ Glass-ionomer</b>	<b>277</b>
<b>PR BOND™</b>	<b>277</b>
<b>PR ETCH™</b>	<b>278</b>
<b>QUICK'N POST™</b>	<b>279</b>
<b>KITE SURF™</b>	<b>280</b>
<b>CHROMALG'X™</b>	<b>284</b>
<b>ORTHOFAST™</b>	<b>284</b>
<b>PRALG'X™</b>	<b>285</b>





# expasyl exact



# expasyl



## Enhance your impression accuracy

### A TRIPLE ACTION

#### 1 ASTRINGENT EFFECT

helps to completely dry the sulcus with no blood or fluids.

#### 2 OPEN THE SULCUS

effectively with no pain or damage to tissues thanks to the viscosity carefully calculated with our clinical expertise.

#### 3 PRESERVE EPITHELIAL ATTACHMENT\*

for a reduced risk of gingival recession and bone resorption.

\* Canula must not be inserted into the sulcus

### EXPASYL™ PASTE USED BY EXPERTS

**97%** of Expasyl™ paste users **would recommend** this product to a colleague\*\*

**93%** of Expasyl™ paste users say that **the sulcular opening obtained** with the product **is ideal for impression taking\*\***

**94%** of Expasyl™ paste users find that the **application is very easy\*\***

### WHY CHOOSE EXPASYL™ RETRACTION PASTE?

Compared to traditional cords, Expasyl™ paste preserves gingival tissues and epithelial attachment.<sup>(1)</sup> Expasyl™ paste generates pressure 1.7 to 9.2 times greater than other retraction paste available on the market.<sup>(2)</sup>

\*\* 2023 survey conducted among 270 French dentists

## ENSURE COMPLETE SUCCESS OF YOUR PROSTHETIC RESTORATIONS



Dr Erwan BOULIC  
Dentist - France

Expasyl™ paste allows full access to emergence profile to guarantee the most natural finish

## ATRAUMATIC SULCULAR OPENING



**EASILY APPLIED**  
**20 SECONDS**



**WORKS IN**  
**1-2 MINUTES**  
max



**EASILY REMOVED**  
with a gentle  
air/water spray



(1) Bennani V, Aarts JM, He LH. A comparison of pressure generated by cordless gingival displacement techniques. J Prosthet Dent. 2012 June;107(6):388-92.

(2) Klettie T, Schulte C. Force required to displace Pastes and gels for Gingival retraction. 2012 AADR Annual Meeting (Tampa, Florida) – Poster Session ID 1364.

## expasyl exact



**Expasyl™ Exact x 50**

**261 011**



**Expasyl™ Exact x 20**

**261 010**



**Universal applicator gun**

**260 920**

## expasyl



**Expasyl™ Minikit**  
with 6 capsules + 12 straight cannulas  
+ 1 applicator

**294 100**



**Capsules, strawberry flavour x 20**

**261 001**



**Capsules x 20**

**261 030**



**Pre-bent cannulas x 40**

**261 045**



**Pre-bent cannulas x 100**

**261 015**



**Straight cannulas x 40**

**261 040**



**Straight cannulas x 100**

**261 005**



**Manual applicator**

**260 900**



## cav-hycal

Light-curing, radiopaque one-component material containing calcium hydroxide

### Indications

Indirect pulp capping  
Lining under all filling materials

### Advantages

- Effective protection of the pulp
- Ready-to-use one-component material
- Time-saving light-curing and direct application from the syringe
- High level of acid-resistance, protection when applying the total-etch technique
- Supports the formation of tertiary dentine

### CAV-Hycal™

2 x 2ml syringes and 20 disposable tips

213 876

Class IIa medical device (MEDCERT) - CE 0482 - Manufacturer: MP Medical Product - Germany  
Distributed by: PRODUITS DENTAIREs PIERRE ROLLAND - ACTEON® Group - France



## coolsin plus

Self-cure resin for temporary bridges and crowns

### Indication

Temporary crowns and bridges

### Properties

- Natural and aesthetic shades
- Flexural strength > 100 MPa
- Very thin oxygen inhibition layer
- Easy finishing & polishing

### COOLSIN™ Plus

1 double cartridge of 50ml, 10 single-use mixing tips

201 070

### COOLSIN™ Plus mixing tips x 100

200 073

Class IIa medical device (TUV Rheinland) - CE 0197 - Manufacturer: G-Pharma - France  
Distributed by: PRODUITS DENTAIREs PIERRE ROLLAND - ACTEON® Group - France



## pr scell glass ionomer

Cementation of crowns, bridges and inlays

### Properties

- Excellent handling properties
- Low film thickness
- Less moisture sensitivity during the initial setting stage
- Prolonged working time
- It releases fluoride
- Radiopaque

Complies with ISO 9917-1

"Dentistry - Water-based cements - Part 1: Powder/liquid acid-base cements"

### Composition

- Powder: fluoroaluminosilicate glass, excipients
- Liquid: acrylic acid and tricarboxylic acid copolymers, excipients

### PR SCELL™ Glass-Ionomer

15g of powder, 8ml of liquid, 1 powder spoon

213 770

Class IIa medical device (GMED) - CE 0459 - Manufacturer: PRODUITS DENTAIREs PIERRE ROLLAND - ACTEON® Group - France

Available for sale until stock clearance



## pr bond

Light & dual-cure desensitizing bonding system

### Properties

- Light & dual cure: Used alone, Part A is a light-cure bonding. When mixed with Part B (activator), the bonding system become dual-curing
- Shear strength: ~ 13 Mpa
- No post-operative sensitivity

### PR BOND™

2 bottles of liquid (5ml adhesive + 5ml catalyst)

200 948

Class IIa medical device (TUV Rheinland) - CE 0197 - Manufacturer: G-Pharma - France  
Distributed by: PRODUITS DENTAIREs PIERRE ROLLAND - ACTEON® Group - France



## pr etch

Etching gel for the surface treatment of enamel and dentin

### Properties

- Thixotropic gel: remains in place on the tooth but rinses off easily and quickly, without leaving residues
- Blue color for a good contrast

### Composition

- 38% phosphoric acid

### PR ETCH™

4 x 1.5g syringe of gel, 10 disposal needle tips applicators

200 322

Class IIa medical device (TUV Rheinland) - CE 0197 - Manufacturer: G-Pharma - France  
Distributed by: PRODUITS DENTAIRE PIERRE ROLLAND - ACTEON® Group - France



## quick'n post

Glass fiber endodontic posts and drills

### Indication

Posts for dental reconstruction, particularly for teeth with little or no remaining crown tissue

### Properties

- Translucent glass fiber
- Conical-cylindrical shape respecting the shape of the root canal
- Highly resistant: modulus of elasticity similar to dentin
- Retentive surface: highly adhesion with cements
- Radiopaque
- Biocompatible
- Single use [posts]
- Easy to identify thanks to its coloured central axis
- Easy to remove, if clinically required, its coloured soft micro-fiber filament permits to guide instruments for drilling it

### Composition

- Post: composite reinforced with glass fiber (≈ 70% in vol) in an epoxy resin matrix
- Drill: stainless steel



### QUICK'N POST™

Kit: 15 posts (Size 1 x5, size 2 x5, size 3 x5) + 3 drills

251 185



**Posts size 0 x 10**  
inferior incisors (refill only)

251 189

**Posts size 1 x 10**  
inferior incisors and first superior premolars

251 186

**Posts size 2 x 10**  
inferior incisors and first superior premolars

251 187

**Posts size 3 x 10**  
inferior incisors and first superior premolars

251 188



**Drill size 0 x 1**

251 181

**Drill size 1 x 1**

251 182

**Drill size 2 x 1**

251 183

**Drill size 3 x 1**

251 184



QUICK'N POST SIZE (mm)	0	1	2	3
MAXIMUM DIAMETER	1.20	1.40	1.60	1.80
MINIMUM DIAMETER	0.70	0.80	0.80	0.90
CONICITY (%)	0.04	0.05	0.066	0.08
LENGHT	19	19	19	19

Class IIa medical device (ICIM) - CE 0425 - Manufacturer: OVERFIBERS S.r.l. - Italy  
Distributed by: PRODUITS DENTAIRE PIERRE ROLLAND - ACTEON® Group - France

# kite surf putty soft

Addition silicone for precision impressions

## Indication

Dual mixture impression (1 step), wash technique impression (2 steps) or triple viscosity impression

## Properties

- Hydrophilic
- High viscosity
- Time management (snap-set effect)
- Bubble gum flavour

### Kite Surf™ Putty Soft Normal Setting<sup>(1)</sup>

1 x 300ml jar of base, 1 x 300ml jar of catalyst, 2 spoons

281 100

### Kite Surf™ Putty Soft Fast Setting<sup>(1)</sup>

1 x 300ml jar of base, 1 x 300ml jar of catalyst, 2 spoons

281 300



## Composition

Polyvinylsiloxane, silica, excipients

# kite surf putty soft XL

Addition silicone for precision impressions

## Indication

Dual mixture impression (1 step), wash technique impression (2 steps) or triple viscosity impression

## Properties

- Hydrophilic
- High viscosity
- Time management (snap-set effect)
- Bubble gum flavour
- Cartridges compatible with the most common mixing machines

### Kite Surf™ Putty Soft XL Normal Setting<sup>(1)</sup>

2 x 380ml XL cartridges (base and catalyst); 20 mixing tips and 2 locking rings

270 012

### Kite Surf™ Putty Soft XL Fast Setting<sup>(1)</sup>

2 x 380ml XL cartridges (base and catalyst); 20 mixing tips and 2 locking rings

270 004

### Kite Surf™ XL mixing tips<sup>(2)</sup> x 50

281 524



## Composition

Polyvinylsiloxane, silica, excipients

# kite surf heavy XL

Addition silicone for precision impressions

## Indication

For filling impression trays when using the double-mixing technique

## Properties

- Heavy bodied consistency, fast setting
- Cartridges compatible with the most common mixing machines

### Kite Surf™ Heavy XL<sup>(1)</sup>

2 x 380ml XL cartridges (base and catalyst); 20 mixing tips and 2 locking rings

270 005

### Kite Surf™ XL mixing tips<sup>(2)</sup> x 50

281 524



## Composition

Polyvinylsiloxane, silica, catalyst, excipients

# kite surf regular

Addition silicone for precision impressions

## Indication

- Corrective impression in the dual mixture technique (suitable for injection)
- Single-phase impression with individual impression carrier

## Properties

- Medium viscosity
- Total setting time: 5min 30s

### Kite Surf™ Regular Normal Setting<sup>(1)</sup>

2 x 50ml cartridges (base and catalyst) and 12 mixing tips

281 380

### Kite Surf™ Regular mixing tips<sup>(2)</sup> x 48

281 542

### Kite Surf™ oral tips<sup>(2)</sup> x 96

281 538

### Kite Surf™ applicator<sup>(2)</sup>

281 532



## Composition

Polyvinylsiloxane, silica, catalyst, excipients

(1) Class I medical devices - CE - Manufacturer: PRODUITS DENTAIRE PIERRE ROLLAND - ACTEON® Group - France

(2) Class I medical devices - CE - Manufacturer: PHASE - Italy - Distributed by: PRODUITS DENTAIRE PIERRE ROLLAND - ACTEON® Group - France

# kite surf basic light

Addition silicone for high precision impressions

## Indication

Dual mixture impression (1 step), wash technique impression (2 steps)

## Properties

- High hydrophily
- Low viscosity
- Time management (snap-set effect)
- Bubble gum flavour

### Kite Surf™ Basic Light Normal Setting<sup>(1)</sup>

2 x 50ml cartridges (base and catalyst) and 12 mixing tips

281 375

### Kite Surf™ Basic Light Fast Setting<sup>(1)</sup>

2 x 50ml cartridges (base and catalyst) and 12 mixing tips

281 370

### Kite Surf™ mixing tips<sup>(2)</sup> x 48

281 537

### Kite Surf™ oral tips<sup>(2)</sup> x 96

281 538

### Kite Surf™ applicator<sup>(2)</sup>

281 532

<sup>(1)</sup> Class I medical devices - CE - Manufacturer: PRODUITS DENTAIRES PIERRE ROLLAND - ACTEON® Group - France

<sup>(2)</sup> Class I medical devices - CE - Manufacturer: PHASE - Italy - Distributed by: PRODUITS DENTAIRES PIERRE ROLLAND - ACTEON® Group - France



## Composition

Polyvinylsiloxane, silica, catalyst, excipients

# kite surf light

Addition silicone for high precision impressions

## Indication

Dual mixture impression (1 step), wash technique impression (2 steps)

## Properties

- High hydrophily
- Low viscosity - very fluid consistency
- Time management (snap-set effect)
- Bubble gum flavour

### Kite Surf™ Light Normal Setting<sup>(1)</sup>

2 x 50ml cartridges (base and catalyst) and 12 mixing tips

281 150

### Kite Surf™ Light Fast Setting<sup>(1)</sup>

2 x 50ml cartridges (base and catalyst) and 12 mixing tips

281 350

### Kite Surf™ mixing tips<sup>(2)</sup> x 48

281 537

### Kite Surf™ oral tips<sup>(2)</sup> x 96

281 538

### Kite Surf™ applicator<sup>(2)</sup>

281 532



## Composition

Polyvinylsiloxane, silica, catalyst, excipients

# kite surf occlusion

Bite registration material

## Indication

Bite registration material based (addition curing silicone)

## Properties

- Colour: yellow
- Fast setting
- High viscosity
- Easy to use (thixotropic)
- Easy to remove
- High final hardness
- High dimensional stability

### Kite Surf™ Occlusion<sup>(1)</sup>

2 x 50ml cartridges (base and catalyst), 12 mixing tips and 12 intraoral tips

281 175

### Kite Surf™ Regular mixing tips<sup>(2)</sup> x 48

281 542

### Kite Surf™ applicator<sup>(2)</sup>

281 532



## Composition

Polyvinylsiloxane, silicone dioxide, excipients

# chromalg'x

## Alginate-based impression material

### Indication

Dental impressions

### Properties

- Chromatic alginate: its color changes according to the progression of setting reaction
- Blue color, Raspberry flavour
- Setting time: 2min 20s to 2min 40s
- Complies with Standard ISO 1563: Alginate-based dental impression

### Composition

Alginate salts, Mineral charge, Colouring agents and food flavourings



#### CHROMALG'X™

1 box containing 2 x 500g bags, powder and water dosing system

263 617

#### CHROMALG'X™ ECO

1 box, 12 x 500g bags, powder and water dosing system

263 618

#### CHROMALG'X™ CLINIC

24 x 500g bags, powder and water dosing system

263 619

Class I medical devices - CE - Manufacturer: PRODUITS DENTAIRE PIERRE ROLLAND - ACTEON® Group - France

# orthofast

## Alginate-based impression material

### Indication

Dental impressions

### Properties

- Very short setting time, specially for orthodontics: 1 min 40s to 2min
- Orange colour, Apricot flavour
- Complies with Standard ISO 1563: Alginate-based dental impression

### Composition

Alginate salts, Mineral charge, Colouring agents and food flavourings



#### ORTHOFAST™

1 box containing 2 x 500g bags, powder and water dosing system

263 621

#### ORTHOFAST™ ECO

1 box, 12 x 500g bags, powder and water dosing system

263 622

#### ORTHOFAST™ CLINIC

24 x 500g bags, powder and water dosing system

263 623

Class I medical devices - CE - Manufacturer: PRODUITS DENTAIRE PIERRE ROLLAND - ACTEON® Group - France

# pralg'x

## Alginate-based impression material

### Indication

Dental impressions

### Properties

- High resistant alginate
- Setting time: 2min 10s to 2min 30s
- Green colour, Mint flavour
- Complies with Standard ISO 1563: Alginate-based dental impression

### Composition

Alginate salts, Mineral charge, Colouring agents and food flavourings



#### PRALG'X™

1 box containing 2 x 500g bags, powder and water dosing system

263 614

#### PRALG'X™ ECO

1 box, 12 x 500g bags, powder and water dosing system

263 615

#### PRALG'X™ CLINIC

24 x 500g bags, powder and water dosing system

263 616

Class I medical devices - CE - Manufacturer: PRODUITS DENTAIRE PIERRE ROLLAND - ACTEON® Group - France



# PROPHYLAXIS & PERIODONTICS

.....

<b>Curodont™ Repair</b>	<b>288</b>
<b>AIR-N-GO® Classic powders</b>	<b>290</b>
<b>AIR-N-GO® Perio powder</b>	<b>290</b>
<b>Sitsalicine™</b>	<b>291</b>





# Reverse the irreversible with Curodont™ Repair

Curodont™ Repair is a **unique biomimetic system to arrest and reverse early caries** through Guided Enamel Regeneration.



### EFFICACY

93% arrest and regression of initial lesions



### FAST APPLICATION

Application completed within 5-10 mins



### SATISFACTION

80% of patients have a good experience\*



### PRODUCTIVITY

Fast application product to perform more treatments



### INNOVATION

Patented biomimetic P11-4 Monomer-Peptide formulation



### SAFETY

Non-invasive and pain-free treatment

\*practitioners feedback

INNOVATION

# The solution for initial caries

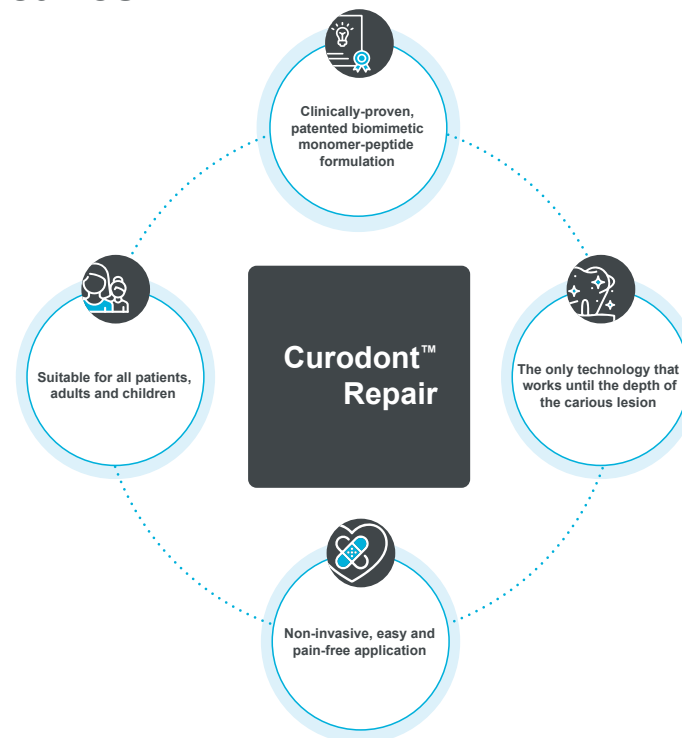

### Visible Evidence

- Reverses the progression of initial caries
- Regenerates enamel
- Deeply remineralizes
- Only one application per lesion, easy-to-use



**Curodont™ Repair**  
1 box of 10 applicators

200 125

Product sold exclusively in France

Class IIa medical device (SQS) - CE 1250 - Manufacturer : Credentis AG - Switzerland.  
Distributed by: PRODUITS DENTAIRE PIERRE ROLLAND - ACTEON® Group - France

## air-n-go classic

### Polishing powders - Sodium bicarbonate-based ( $\approx 76\mu\text{m}$ )

- Complete range of active **supra-gingival powders** which meet any patients' preferences
- Scrupulous cleaning giving instant results
- Action of removing coloured stains and bacterial plaque, even in areas that are difficult to access
- Better patient comfort: gentle and efficient with limited bleeding during treatment
- 5 fresh flavours based on 100% natural aromas or essential oils



#### AIR-N-GO® "CLASSIC" powder<sup>(1)</sup> - 4 bottles (250g)

Peppermint	F10250
Lemon	F10251
Raspberry	F10252
Cola	F10253
Neutral	F10254
4 Flavors (Peppermint, Lemon, Raspberry and Cola)	F10255

## air-n-go perio

### Polishing powders - Natural glycine-based ( $\approx 25\mu\text{m}$ )

- Exclusive use for **sub-gingival treatments** as a complement to the initial therapy
- Low abrasiveness preserving the treated surfaces (teeth and implants) and the most fragile anatomical areas
- Prevents the progression of the sub-gingival biofilm
- Multiple advantages with unique properties:
  - Plaque removal: during periodontal maintenance on exposed root surfaces without sacrificing substance
  - Reduction of the bacterial load in the periodontal pockets



#### AIR-N-GO® "PERIO" powder<sup>(2)</sup> 3 bottles (160g)

F10270

(1) Class IIa medical device - (GMED) - CE 0459 - Manufacturer: SATELEC® - ACTEON® Group - France

(2) Powder for subgingival treatment of periodontitis and peri-implantitis - Class IIa medical device - (GMED) - CE 0459 - Manufacturer: SATELEC® - ACTEON® Group - France

## sitsalicine

### Polishing teeth after scaling

#### Properties

Silica is a mildly abrasive powder which gives the paste its polishing properties, eliminating the micro-roughness that is present after scaling, without damaging the enamel or gums. A flavouring compound gives its pleasant, refreshing taste.



#### Sitsalicine™ 60g tube

277 803

Class IIa medical device (GMED) - CE 0459 - Manufacturer: PRODUITS DENTAIRE PIERRE ROLLAND - ACTEON® Group - France



# ENDODONTICS

.....

<b>IrriFlex®</b>	<b>294</b>
<b>SALVIZOL™ E.D.T.A.</b>	<b>296</b>
<b>MTA* CAPS</b>	<b>297</b>
<b>HYCAL™</b>	<b>297</b>
<b>Cortisomol™ SP kit</b>	<b>298</b>
<b>Eugenol Pur</b>	<b>298</b>
<b>Sealite™ Regular kit</b>	<b>299</b>
<b>Cimavit™</b>	<b>299</b>
<b>Cimavit™ Photo</b>	<b>300</b>
<b>Desocclusol™ Orange</b>	<b>300</b>

\* Mineral Trioxide Aggregate



# Flexibility and Precision. Easy root canal irrigation.

## FLEXIBILITY

Unlike conventional metal needles, Irriflex® is made of a soft polypropylene body which is **dentin friendly** and that can easily adapt to complex root canal anatomy, go as close to the apex and **irrigate areas once impossible to reach**.



## EFFICIENCY

Irriflex® design encompasses 2-side vents back to back at the tip to deliver **balanced lateral irrigation** and a tapered shape to match root canal preparation and **increase shear stress along the root canal walls**.

The result is **enhanced cleaning and irrigation for an improved removal of residues** such as debris, smear layer and biofilm.



## COMFORT

The unique design of Irriflex® provides an **exceptional glide in the root canal** and improves accessibility. Combining a unique 2-side vent pattern with a tapered shape, that **makes solution delivery remarkably effortless**.

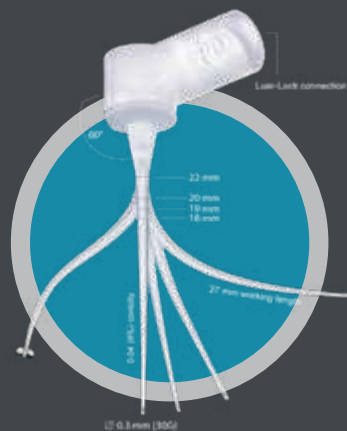

NEW

# Flexible needle for advanced root canal irrigation

The Irriflex® flexible needle ensures **safe, effective and complete irrigation of the root canal** to improve the removal of residues such as debris, smear layer and biofilm in areas that cannot be reached with conventional metal needles.\*

\* Irriflex, une canule de conception innovante pour l'irrigation canalaire avancée, Dental Tribune France, 2019 March

“

*Irriflex® offers the benefit of being able to be inserted very deeply into the most curved root canals without the risk of extrusion into the periapex. Mounted on a 5 ml Luer-Lock syringe, the orientation of the lateral openings located on the same plane 0.5 mm from its end creates useful shear stress forces to eliminate the smear layer and disorganize bacterial biofilms from the root canal walls.*

*Prof. Pierre Machtou*



Irriflex®  
1 box of 40 flexible needles

21401-001

# salvizol E.D.T.A

## Root canal irrigant

### Properties

Thanks to its chelating properties, SALVIZOL™ E.D.T.A. dissolves the mineralizing screen, facilitating removal of the smear layer. It contains a quaternary ammonium salt to efficiently wet the dentin wall and produce a foam, thus avoiding apical sedimentation of debris.

When used in combination with sodium hypochlorite (NaClO), SALVIZOL™ E.D.T.A. makes it possible to obtain clean dentin walls and satisfactory opening of the tubules, so that the canal can then be optimally obturated.

### Composition

Edetic acid: 8g/100g under dihemipotassium salt form, excipients



**SALVIZOL™ E.D.T.A.**  
250ml bottle

266 115

Class IIa medical device (GMED) - CE 0459 - Manufacturer: PRODUITS DENTAIRE PIERRE ROLLAND - ACTEON® Group - France

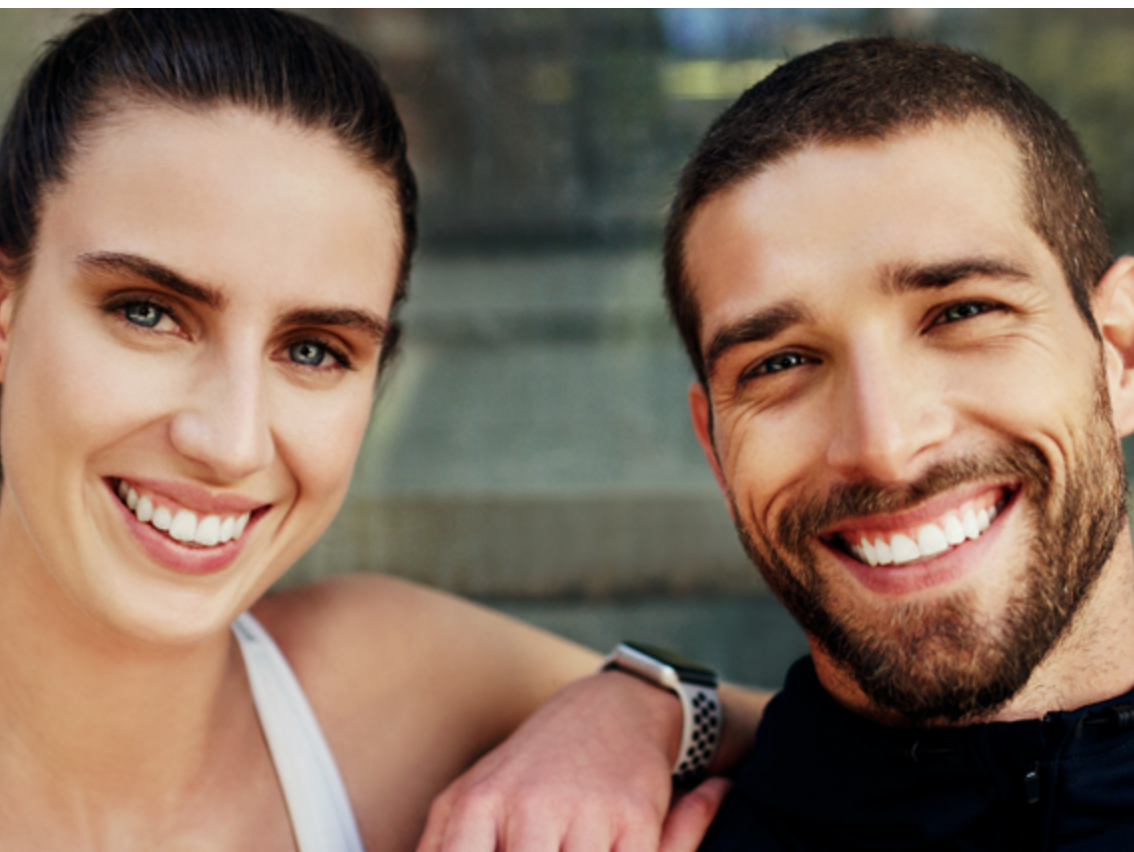

# MTA caps

## Endodontic repair cement

### Indications

- Root end filling (retrograde)
- Repair of root perforations during root canal therapy
- Pulp capping
- Root end filling (orthograde)

### Properties

- Biocompatible
- Barrier impervious to bacteria and fluids
- Radiopaque
- Easy to use
- Delivered under single-use capsules



### MTA\* CAPS<sup>(1)</sup>

1 aluminium bag with 2 pre-proportioned 0.3g-capsules

251 170

### MTA\* Appli caps<sup>(2)</sup>

213 675

(1) Class IIa medical device (MEDCERT) - CE 0482

(2) Class I medical device - CE

Manufacturer: First Scientific Dental GmbH - Germany

Distributed by: PRODUITS DENTAIRE PIERRE ROLLAND - ACTEON® Group - France

\* Mineral Trioxide Aggregate

# hycal

## Ready-to-use calcium hydroxide paste

### Indications

Hycal™ is a calcium hydroxide paste indicated for application:

- Direct capping when pulp opened or after pulpotomy.
- Indirect capping for treatment of deep caries.
- Lining of cavities to prevent exposure to acid media when using cements
- Temporary filling of root-canals.

### Properties

- Product ready to use.
- High pH (>12.5)
- Effective protection of the pulp.
- Formation of tertiary dentin.
- Radio-opaque.



### HYCAL™

1 x 2ml syringe and 5 additional bended application cannulas

259 314

Class IIa medical device (MEDCERT) - CE 0482 - Manufacturer: MP Medical Product - Germany

Distributed by: PRODUITS DENTAIRE PIERRE ROLLAND - ACTEON® Group - France

# cortisomol sp

## Powder for permanent sealing cement for root canals

### Properties

Permanent root canal sealing allows the tooth to remain functional. The presence of prednisolone acetate (steroidal anti-inflammatory) may help to reduce post-operative pain following endodontic treatment..

In addition, Cortisomol™ SP powder is radiopaque and, although without any colouring agent, its colour makes the canal entry easily visible.

The cement produced must be used in combination with pure eugenol and gutta-percha cones.

### Composition

Prednisolone acetate 1.1%; Diiodothyol; Zinc oxide; Barium sulphate; Magnesium stearate; zinc acetate; Silica, colloidal anhydrous; s.q. 100g.



#### Cortisomol™ SP kit

Jar containing 23g of powder<sup>(1)</sup>; 1 spoon<sup>(2)</sup>

221 606

(1) Class III medical device (GMED) - CE 0459

(2) Class I medical device - CE

Manufacturer: PRODUITS DENTAIRE PIERRE ROLLAND - ACTEON® Group - France

# eugenol pur

## Liquid for zinc-oxide based cement

### Properties

The eugenol confronted with bivalent metallic ions (Zn<sup>2+</sup>) forms a chelate: chemopolymerization.

To be used with Cortisomol™ SP.

### Composition

Eugenol 100%



#### Eugenol Pur

60ml bottle

234 110

Class IIa medical device (GMED) - CE 0459 - Manufacturer: PRODUITS DENTAIRE PIERRE ROLLAND - ACTEON® Group - France

# sealite regular

## Powder and liquid for permanent sealing cement for root canals

### Properties

Cement allows the tooth to remain functional.

- Cement that spreads completely into canals
- Very thin film thickness
- Very low disintegration
- Easy to handle: adequate working time, with a setting time that allows placement of gutta cones regardless of the method used
- Radiopaque
- Homogeneous consistency

In compliance with ISO 6876

Must be used with gutta percha cones.

### Composition

- Sealite™ Regular powder: Diiodothyol - Zinc oxide - Radio-opacifier - Excipients
- Sealite™ Liquide: Eugenol - Excipients



#### Sealite™ Regular kit

25g of Sealite™ Regular Powder<sup>(1)</sup>, 10ml of Sealite™ Liquide<sup>(1)</sup>, 1 spoon<sup>(2)</sup>, 1 dropper<sup>(2)</sup>

266 264

#### Sealite™ Liquide<sup>(1)</sup>

10ml (refill)

266 267

(1) Class IIa medical devices (GMED) - CE 0459

(2) Class I medical devices - CE

Manufacturer: PRODUITS DENTAIRE PIERRE ROLLAND - ACTEON® Group - France

# cimavit

## Zinc oxide-based temporary filling cement

### Properties

- Ready-to-use (no mixing)
- Waterproof
- Very good adherence to dentine
- Immediate setting time in mouth
- Easy to remove (probe, excavator, ...)
- Pink colour for a good contrast



#### Cimavit™

6 x 28g jars

213 859

Class IIa medical device (TUV Rheinland) - CE 0197 - Manufacturer: G-Pharma - France

Distributed by: PRODUITS DENTAIRE PIERRE ROLLAND - ACTEON® Group - France

## cimavit photo

Light-curing filling material for temporary restorations

### Indications

- Temporary fillings
- Temporary sealing of cavities, especially in inlay / onlay technique

### Advantages

- Easy to place – easy to remove in one piece
- No damage to preparation boundaries
- Time-saving and economical
- Durable and saliva-proof
- Specifically useful in inlay / onlay technique

**Cimavit™ Photo**  
2 x 4g syringes

213 380

Class IIa medical device (MEDCERT) - CE 0482 - Manufacturer: MP Medical Product GmbH - Germany  
Distributed by: PRODUITS DENTAIRE PIERRE ROLLAND - ACTEON® Group - France



## desocclusol orange

Solvent for eugenate root canal filling cements  
(zinc oxide/eugenol + gutta-percha)

### Properties

Facilitates mechanically the removing of the fillings from the root-canal:

- High dissolving capacity of zinc-oxide / eugenol based cement and gutta percha

### Composition

Orange essential oil

**Desocclusol™ Orange**  
14ml bottle

226 022

Class IIa medical device (GMed) - CE 0459 - Manufacturer: PRODUITS DENTAIRE PIERRE ROLLAND - ACTEON® Group - France



# ANESTHETICS & SURGERY

.....

<b>Primacaïne™ Adrenaline</b>	<b>304</b>
<b>Xylorolland™ sans vasoconstricteur</b>	<b>307</b>
<b>Friljet™</b>	<b>307</b>
<b>Etik™ Collagene</b>	<b>308</b>
<b>HemostasyI™</b>	<b>309</b>
<b>Sterile dental needles</b>	<b>310</b>
<b>Dental silk sutures</b>	<b>311</b>





# Efficacy & safety for dental anesthesia

As per literature review over the last 10 years<sup>(1)</sup>, articaine has been researched the most and has the **highest efficacy** of amides used in dental local anesthesia.

<sup>(1)</sup> Efficacy of dental local anesthetics: A review, Nelly Badr, Johan Aps, J Dent Anesth Pain Med 2018 December; 18(6): 319-332

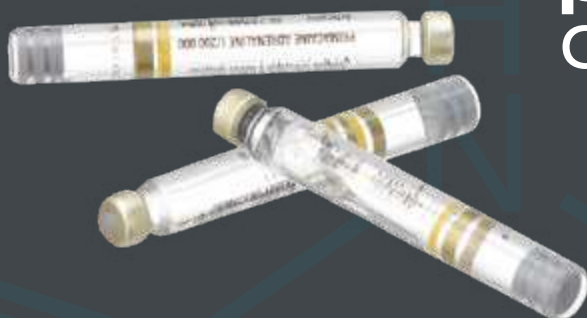

## primacaïne adrénaline

### ARTICAINE HYDROCHLORIDE

- Local anesthetic with an amide function
- Interrupts the nerve impulse along the nerve fiber at the injection site

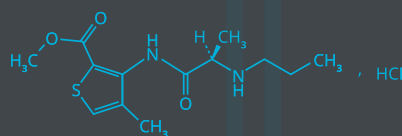

### EPINEPHRINE (ADRENALINE) TARTRATE

- Delays the passage of articaine into the systemic circulation and maintains an active tissue concentration
- Little hemorrhagic operative field
- 2 concentrations of adrenaline are proposed: 1/100 000 or 1/200 000  
Primacaïne™ 1/100 000 is particularly adapted when procedures require a high ischemia

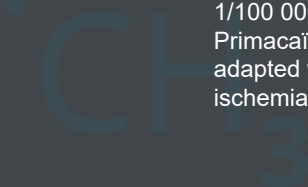
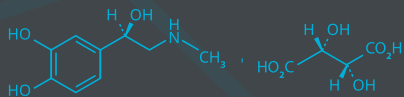

### EUROPEAN PHARMACEUTICAL MANUFACTURING

Consistent production and quality process according to international quality standards:

- Raw materials compliant with European Pharmacopoeia
- Constant quality of the finished product
- Long-proven production process compliant to GMP\* in force

### ASEPTIC MANUFACTURING

- Aseptic filling process
- Undegraded epinephrine (compared to final sterilization process)
- No pH variation for optimal efficiency
- **Less** potentially degradation products

### PRODUCT SAFETY

Rigorous quality testing all along the manufacturing process.

Electronic optical control of all the cartridges:

- Maximum reliability
- Constant quality: 1 million cartridges inspected per day

\*Good Manufacturing Practice

# primacaine adrenaline 1/200000

Injectable solution for dental use.

Articaine chlorhydrate - Epinephrine (adrenaline) tartrate.



## Indication

Local or loco-regional anaesthesia in odonto-stomatological practice.

## Its advantages

- Contains 4% Articaine Hydrochloride and 1/200,000 adrenaline
- Less manufacturing stages: Faster manufacturing procedure making it possible to reduce the potential risks of oxidation of the adrenaline
- Sodium edetate-free
- Low Sulphite\* content: 0.85mg sodium metabisulphite per cartridge, i.e. 0.337mg/ml in equivalent SO<sub>2</sub>

**Primacaine™ Adrenaline 1/200 000**

Box of 50 cartridges

262 220

Summary of product characteristics at the end of the catalogue.

This product is a medicinal product. Available only if registered by the National Competent Authorities.

Not available in UE except France

\* vasoconstrictor preservatives with antioxidant properties

# primacaine adrenaline 1/100000

Injectable solution for dental use.

Articaine chlorhydrate - Epinephrine (adrenaline) tartrate.



## Indication

Local or loco-regional anaesthesia in odonto-stomatological practice

This presentation is especially suitable for procedures requiring a high degree of ischaemia

## Its advantages

- Contains 4% Articaine Hydrochloride and 1/100,000 adrenaline
- Less manufacturing stages: Faster manufacturing procedure making it possible to reduce the potential risks of oxidation of the adrenaline
- Sodium edetate-free
- Low Sulphite\* content: 0.85mg sodium metabisulphite per cartridge, i.e. 0.337mg/ml in equivalent SO<sub>2</sub>

**Primacaine™ Adrenaline 1/100 000**

Box of 50 cartridges

262 215

Summary of product characteristics at the end of the catalogue.

This product is a medicinal product. Available only if registered by the National Competent Authorities.

Not available in UE except France

\* vasoconstrictor preservatives with antioxidant properties

# xylorolland sans vasoconstricteur

Injectable solution for dental use.

Lidocaine chlorhydrate.



## Indication

- Local or loco-regional anaesthesia in odonto-stomatological practice
- This preparation is particularly used when the use of a vasoconstrictor is not recommended

## Its advantages

- Contains 2% Lidocaine Hydrochloride
- Low sodium metabisulphite content: 0.15%

**Xylorolland™ sans Vasoconstricteur**

Box of 50 cartridges

291 462

Summary of product characteristics at the end of the catalogue.

This product is a medicinal product. Available only if registered by the National Competent Authorities.

Not available in UE except France

# friljet

Local cryoanaesthesia - Pulp vitality test (cold sensivity)

## Indication

- Local cryoanaesthesia for short procedures: abscess incision, extraction of deciduous teeth, roots, pyorrhoeic teeth, desensitisation of the injection point
- Pulp vitality test: Lowering of the temperature of the dental enamel causes a stimulation of the dental pulp (slight pain) making it possible to check the vitality of the tooth tested.

## Properties

The tetrafluoroethane contained in Friljet™ exerts an anaesthetic action by cooling: its fast evaporation from the surface to which it is applied causes a significant reduction of the temperature of this surface for several dozen of seconds. When the temperature reduction reaches the synaptic transmission threshold, surface anaesthesia occurs.

**Friljet™**

200g (171.5ml) bottle + cannula

239 803

Class IIa medical device (GMED) - CE 0459 - Manufacturer: PRODUITS DENTAIRE PIERRE ROLLAND - ACTEON® Group - France



This product induces a tissue temperature reduction down to -25°C, and may cause tissue necrosis if the instructions for use are not respected.

Routinely use FRILJET™ with the cannula.



# etik collagene

## Hemostatic surgical dressing

### Properties

Collagen is a fibrillar protein naturally present in all connective tissues.

Lyophilized collagen in cylindrical form displays hemostatic activity due to its adhesive power, liquid absorption and gelification properties.

The collagen cylinder moulds itself into the hemorrhagic surface where it adheres strongly upon mechanical compression, thus promoting the formation and maintenance of a platelet clot (coagulation).

The collagen cylinders are resorbable.

### Composition

Native, non-denatured, lyophilized bovine collagen (mainly type I collagen): 100%. This device contains tissues of animal origin under regulation (EU) no. 722/2012.

Dimensions: diameter ≈ 10mm, height ≈ 16mm



### Etik™ Collagene

25 unit-packaged sterile cylinders (in blister packs)

281 970

Class III medical device (GMED) - CE 0459 - Manufacturer: PRODUITS DENTAIREs PIERRE ROLLAND - ACTEON® Group - France

# hemostasyI

## Hemostatic dressing

### Indication

To be used in all cases of moderate bleeding occurring in routine dental practice (scaling, etc.)

### Properties

- Thixotropic properties
- Good adhesion to the gingival mucosa, without compression
- Presence of aluminum chloride which reinforces its mechanical hemostatic effect
- Placed directly in the mouth with the single-use angled cannula
- Easily located due to its color
- Easily removed by gentle water spray without resumption of bleeding
- Painless on a healthy periodontium
- Contact time: 2 minutes max.



### HemostasyI™ kit

2 x 2g-syringes<sup>(1)</sup> + 40 cannulas<sup>(2)</sup>

246 200

### HemostasyI™ syringes

2 x 2g-syringes<sup>(1)</sup>

246 050

### HemostasyI™ cannulas<sup>(2)</sup> x 40

246 100

(1) Class IIa medical device (GMED) - CE 0459

(2) Class I medical device - CE

Manufacturer: PRODUITS DENTAIREs PIERRE ROLLAND - ACTEON® Group - France



# aiguilles dentaires stériles

## Sterile dental needles

### Properties

- European thread hub
- Plastic hub
- Silicone coated
- Triple bevel
- Sterile
- Complies with NF EN ISO 7885 standard "Dentistry - Sterile injection needles for single use"

<b>Sterile dental needles 8mm/27G</b> - Box of 100 needles	<b>201 441</b>
<b>Sterile dental needles 12mm/30G</b> - Box of 100 needles	<b>201 440</b>
<b>Sterile dental needles 16mm/30G</b> - Box of 100 needles	<b>201 444</b>
<b>Sterile dental needles 21mm/30G</b> - Box of 100 needles	<b>201 445</b>
<b>Sterile dental needles 21mm/27G</b> - Box of 100 needles	<b>201 446</b>
<b>Sterile dental needles 35mm/25G</b> - Box of 100 needles	<b>201 448</b>

Class IIa medical devices (BSI) - CE 2797 - Manufacturer: SOFIC - France  
Distributed by: PRODUITS DENTAIRE PIERRE ROLLAND - ACTEON® Group - France

For professional dental use only, not covered by health insurance under the LPPR. Read the instructions for use before use.



# soie dentaire

## Non-resorbable silk strands

### Indication

Dental suture in dental surgery and stomatology

### Properties

- Soie dentaire 3/0: Needle: length 18mm, radius of curvature 3/8ème, non-traumatising triangular shape. Strand: diameter Dec 2, length 45cm.
- Soie dentaire 4/0: Needle: length 12mm, radius of curvature 3/8°, non-traumatising triangular shape. Strand: diameter Dec 1.5, length 45cm.
- Soie Dentaire is non-resorbable silk strands obtained by braiding varying numbers of silk strands depending on the desired thickness. Soie Dentaire is coated with natural wax after braiding. It is black, not very elastic but very flexible. It is easy to handle and improves surgical comfort considerably as it has almost no shape memory.

### Composition

- Needle: stainless steel
- Strand: silk = proteinic fibre (fibroin) made essentially of repeated amino-acids sequences from the unwinding of silkworm's cocoons

<b>Dental Silk sutures 4/0 DEC 1.5</b> 12-pouch case	<b>280 201</b>
<b>Dental Silk sutures 3/0 DEC 2</b> 12-pouch case	<b>280 101</b>

Class IIb medical devices (MEDCERT) - CE 0482 - Manufacturer: PETERS SURGICAL - France  
Distributed by: PRODUITS DENTAIRE PIERRE ROLLAND - ACTEON® Group - France





---

# **ACTEON®**

## **OEM**

<b>ULTRASONICS</b>	<b>314</b>
<b>MOTORS</b>	<b>328</b>
<b>CURING LIGHT</b>	<b>332</b>
<b>INTRAORAL CAMERAS</b>	<b>339</b>

# ULTRASONICS

.....

<b>SP NEWTRON®</b>	<b>316</b>
<b>SP NEWTRON® LED</b>	<b>318</b>
<b>SP4055 NEWTRON®</b>	<b>320</b>
<b>Standard cords</b>	<b>322</b>
<b>LED cords</b>	<b>323</b>
<b>Handpieces</b>	<b>324</b>
<b>LED rings</b>	<b>325</b>
<b>Accessories</b>	<b>326</b>



# sp newtron



60x50x33mm  
28-36kHz  
0.1 to 12W  
Supply Voltage: 24Vac / 30VA; 34Vdc  
Settings: analog or digital



**SP Newtron® 4K 5V Module**  
with connectors

**F55297**



**SP Newtron® 4K 5V Module**  
with wires

**F55298**



**SP Newtron® 4K3 7V Module**  
with US special connection

**F55287**

Class IIa medical device (GMED) - CE 0459 - Manufacturer: SATELEC® ACTEON® Group - France



[Learn more](#)



Light grey

Medium grey

Dark grey

Surf 6 grey

## SP Newtron® kits

<b>SP Newtron® 4K 5V with light grey cord</b>				<b>F55292</b>
Cord F00195 Ø4x6 / Length 2070mm	Handpiece F12281	Potentiometer F00524	Tips 1, 2, 10P	
<b>SP Newtron® 4K 5V with light grey cord and connectors</b>				<b>F55349</b>
Cord F00239 Ø6x8 / Length 2070mm	Handpiece F12281	Potentiometer F00524	Tips 1, 2, 10P	
<b>SP Newtron® 4K 5V with dark grey cord</b>				<b>F55311</b>
Cord F00426 Ø7x10 / Length 1500mm	Handpiece F12281	Potentiometer F00524	Tips 1, 2, 10P	
<b>SP Newtron® 4K 5V with dark grey cord</b>				<b>F55375</b>
Cord F00187 Ø4x6 / Length 2300mm	Handpiece F12281	Tips 1, 2, 10P		
<b>SP Newtron® Slim B.LED handpiece with light grey cord</b>				<b>F56260</b>
Cord F00426 Ø4.5x5.6 / Length 2080mm	Handpiece F12905	Potentiometer F00522	Tips 1, 2, 10P	
<b>SP Newtron® Slim B.LED handpiece with medium grey cord</b>				<b>F56262</b>
Cord F01201 Ø4.5x5.6 / Length 2080mm	Handpiece F12905	Potentiometer F00522	Tips 1, 2, 10P	
<b>SP Newtron® with light grey cord</b>				<b>F55299</b>
Cord F00239 Ø6x8 / Length 2070mm	Handpiece F12281	Potentiometer F00524	Tips 1, 2, 10P	
<b>SP Newtron® INTL 81" G3 with medium cord</b>				<b>F55383</b>
Cord F01154 Ø5x7 / Length 1900mm	Handpiece F12281	Tips 1, 2, 10P		
<b>SP Newtron® INTL 61" G3 with medium cord</b>				<b>F55385</b>
Cord F011543 Ø5x7 / Length 1400mm	Handpiece F12281	Tips 1, 2, 10P		
<b>SP Newtron® INTL 81" G3 with medium cord</b>				<b>F55453</b>
Cord F01154 Ø5x7 / Length 1900mm	Handpiece F12281	Potentiometer F00523	Tips 1, 2, 10P	
<b>SP Newtron® with dark grey cord</b>				<b>F55372</b>
Cord F00150 Ø4x6 / Length 2300mm	Handpiece F12281	Tips 1, 2, 10P		
<b>SP Newtron® INTL 61" with Surf 6 grey cord</b>				<b>F55285</b>
Cord F00184 Ø5x7 / Length 1400mm	Handpiece F12281	Tips 1, 2, 10P		
<b>SP Newtron® INTL 81" with Surf 6 grey cord</b>				<b>F55452</b>
Cord F00188 Ø5x7 / Length 1900mm	Handpiece F12281	Potentiometer F00525	Tips 1, 2, 10P	

# sp newtron led



75x49x33mm  
 28-36kHz  
 0.1 to 12W  
 Supply Voltage: 24Vac / 30VA; 34Vdc  
 Settings: analog or digital



**SP Newtron® LED 4K 5V Module**  
with connectors

**F55527**



**SP Newtron® LED 4K 5V Module**  
with wires

**F55528**



**SP Newtron® LED4K3 7V Module**  
with US special connection

**F55529**

Class IIa medical device (GMED) - CE 0459 - Manufacturer: SATELEC® ACTEON® Group - France



Learn more



## SP Newtron® LED kits

**SP Newtron® LED 4K 5V with light grey cord** **F55506**

Cord F00606 Ø5x7 / Length 2070mm	Handpiece F12609	Potentiometer F00524	Tips 1, 2, 10P
-------------------------------------	---------------------	-------------------------	-------------------

**SP Newtron® LED 4K 5V with light grey cord** **F55543**

Cord F00614 Ø6x8 / Length 2070mm	Handpiece F12609	Potentiometer F00524	Tips 1, 2, 10P
-------------------------------------	---------------------	-------------------------	-------------------

**SP Newtron® LED with medium grey cord** **F55525**

Cord F00633 Ø5x7 / Length 2300mm	Handpiece F12609	Potentiometer F00524	Tips 1S, 2, 10P
-------------------------------------	---------------------	-------------------------	--------------------

**SP Newtron® LED with medium grey cord** **F55501**

Cord F00633 Ø7x10 / Length 1900mm	Handpiece F12609	Potentiometer F00524	Tips 1, 2, 10P
--------------------------------------	---------------------	-------------------------	-------------------

**SP Newtron® LED INTL 81" handpiece with medium grey cord** **F55454**

Cord F00633 Ø5x7 / Length 1900mm	Handpiece F12609	Potentiometer F00525	Tips 1, 2, 10P
-------------------------------------	---------------------	-------------------------	-------------------

**SP Newtron® LED with dark grey cord** **F55507**

Cord F00618 Ø6x8 / Length 2300mm	Handpiece F12609	Potentiometer F00524	Tips 1, 2, 10P
-------------------------------------	---------------------	-------------------------	-------------------

**SP Newtron® LED with dark grey cord** **F55510**

Cord F00616 Ø5x7 / Length 1400mm	Handpiece F12609	Potentiometer F00524	Tips 1, 10Z, H3
-------------------------------------	---------------------	-------------------------	--------------------

**SP Newtron® LED with dark grey cord** **F55512**

Cord F01182 Ø5x7 / Length 2300mm	Handpiece F12609	Potentiometer F00524	Tips 1, 2, 10P
-------------------------------------	---------------------	-------------------------	-------------------



# sp4055 newtron



Learn more



## SP 4055 Newtron® Module

**F55270**

Class IIa medical device (GMED) - CE 0459 - Manufacturer: SATELEC® ACTEON® Group - France

### SP 4055 Newtron® LED + driver with dark grey cord

**F55377**

Cord F00618	Handpiece	Tips
Ø6x8 / Length 2300mm	F12609	1, H3, 4x K15/21

### SP 4055 Newtron® with light grey cord

**F55240**

Cord F00432	Handpiece	Potentiometer	Tips
Ø7x10 / Length 1900mm	F12281	F00524	1, 2, 10P

### SP 4055 Newtron® with medium grey cord

**F55410**

Cord F00137	Handpiece	Potentiometer	Tips
Ø7x10 / Length 2300mm	F12281	F00524	1, 2, 10P

### SP 4055 Newtron® with dark grey cord

**F56268**

Cord F01157	Handpiece	Tips
Ø6x8 / Length 2300mm	F12281	1, H3, 4x K15/21



Light grey







Medium grey



Dark grey



## Standard cords

	<b>Light grey silicone cord</b> Ø4x6; L 2070cm	<b>F00195</b>
	<b>Light grey silicone cord</b> Ø6x8; L 2070cm	<b>F00239</b>
	<b>Medium grey Newtron® cord 61"</b> Ø5x7; L 1400cm	<b>F01153</b>
	<b>Medium grey Newtron® cord 81"</b> Ø5x7; L 1900cm	<b>F01154</b>
	<b>Dark grey silicone cord</b> Ø4x6; L 2300cm	<b>F00150</b>
	<b>Dark grey silicone cord</b> Ø4x6; L 2300cm	<b>F00187</b>
	<b>Dark grey cord</b> Ø7x10; L 1500cm	<b>F00426</b>
	<b>Dark grey cord</b> Ø6x8; L 2300cm	<b>F01157</b>
	<b>Surf 6 grey Newtron® cord 61"</b> Ø5x7; L 1400cm	<b>F00184</b>
	<b>Surf 6 grey Newtron® cord 81"</b> Ø5x7; L 1900cm	<b>F00188</b>
	<b>Surf 6 grey silicone cord</b> Ø6x8; L 2300cm	<b>F00234</b>

## LED cords

	<b>Light grey LED cord</b> Ø5x7; L 2070cm	<b>F00606</b>
	<b>Light grey Newtron® LED cord</b> Ø6x8; L 2070cm	<b>F00614</b>
	<b>Medium grey Fedesa cord</b> Ø7x10; L 1900cm	<b>F00607</b>
	<b>Medium grey Newtron® LED cord 81"</b> Ø5x7; L 1900cm	<b>F00633</b>
	<b>Dark grey Newtron® LED cord</b> Ø6x8; L 2300cm	<b>F00618</b>
	<b>Surf 6 grey LED cord</b> Ø5x7; L 2300m	<b>F01182</b>
	<b>Surf 6 grey LED cord</b> Ø5x7 ; L 1400m	<b>F00616</b>
	<b>Light grey Newtron® SLIM LED cord</b> Ø4.5x5.6; L 2080cm	<b>F01200</b>
	<b>Medium grey Newtron® SLIM LED cord</b> Ø4.5x5.6; L 2080cm	<b>F01201</b>
	<b>Dark grey Newtron® SLIM LED cord</b> Ø4.5x5.6; L 2080cm	<b>F01202</b>

## Handpieces

	<b>Suprasson handpiece</b> autoclavable, light grey	<b>F12200</b>
	<b>Newtron® handpiece</b> autoclavable, light grey/dark grey	<b>F12281</b>
	<b>Newtron® titanium handpiece</b> autoclavable, light grey/dark grey	<b>F12252</b>
	<b>Newtron® LED handpiece</b> autoclavable	<b>F12609</b>
	<b>Newtron® LED titanium handpiece</b> autoclavable	<b>F12689</b>
	<b>Low voltage Newtron® LED handpiece</b> autoclavable	<b>F12607</b>
	<b>Newtron® SLIM handpiece</b> without LED	<b>F12901</b>
	<b>Low voltage Newtron® SLIM B.LED handpiece</b> with white LED ring	<b>F12905</b>
	<b>Newtron® SLIM B.LED handpiece</b> with white LED ring 11V	<b>F12909</b>

## LED rings

	<b>LED ring</b> for Newtron® LED handpiece	<b>F12605</b>
	<b>LED ring - Low voltage</b> for low voltage Newtron® LED handpiece	<b>F12606</b>
	<b>Newtron® SLIM B.LED blue LED ring</b> for low voltage Newtron® Slim B.LED handpiece	<b>F62201</b>
	<b>Newtron® SLIM B.LED white LED ring</b> for low voltage Newtron® Slim B.LED handpiece	<b>F12915</b>
	<b>Newtron® SLIM B.LED white LED ring</b> 11V - for Newtron® Slim B.LED handpiece	<b>F12932</b>
	<b>Newtron® SLIM B.LED blue LED ring</b> 11V - for Newtron® Slim B.LED handpiece	<b>F12934</b>

## Accessories



**Potentiometer 4.7K**

**F00522**



**Color SP Newtron® potentiometer 4.7K**

**F00524**



**Xinetic potentiometer**

**F55088**



**LUX handpiece SAV OEM Kit**  
to LED handpiece LUX  
with low voltage LED handpiece, low  
voltage LED ring, 2 resistances kit, light  
grey LED handpiece OEM cord Ø5x7  
(2.07m) and 3 o'rings seal + o'ring tool

**F12686**



**Wiring extension SP Newtron®**

**F55205**



**SP Newtron® dummy load**

**F00021**



**SteriPump kit without module**  
with 2 autoclavable irrigation lines and 10  
perforators

**F28653**



**SteriPump module**

**F28660**



**SteriPump + module Kit**  
with a Steri Pump, Steri Pump module,  
2 autoclavable irrigation lines and  
10 perforators

**F28652**



**Complete SteriPump kit**  
Delivered with a Steri Pump, Steri  
Pump module, 2 autoclavable irrigation  
lines and 10 perforators, 5 clips, a 4.7K  
potentiometer

**F28650**

# MOTORS

.....

**Modules**

**330**

**Motors**

**330**

**Cords**

**331**



## Modules



**M6 module**  
without option

**F34300**



**M6P module**  
Pneumatic option with connectors

**F34304**

## Motors



**Light motor**

**F28600**



**AV40 motor**  
External spray

**F28502**

## Cords



**Medium grey cord**  
for light and IS motors

**F33711**



**Medium grey cord**  
for AV motor

**F33712**



**Black coiled cord**  
for light motor

**F33713**



# CURING LIGHT

.....

<b>MiniLED™ Standard</b>	<b>334</b>
<b>MiniLED™ Supercharged</b>	<b>335</b>
<b>Module</b>	<b>336</b>
<b>Cords</b>	<b>336</b>
<b>Light guides</b>	<b>337</b>
<b>Light shield &amp; caps</b>	<b>337</b>



# miniled standard



## MiniLED™ OEM handpiece

**F02710**

## MiniLED™ OEM with module

with a handpiece, a module, a Ø7.5mm opalescent guide, an oval light shield and with:

Surf 6 grey cord	<b>F02505</b>
Medium grey cord	<b>F02719</b>
Dark grey cord	<b>F02720</b>
Gray 3 (Medium grey) cord	<b>F02538</b>

## MiniLED™ OEM with module

with a handpiece, a module, a Ø7.5mm opalescent guide, 2 caps and with:  
Light grey cord

**F02715**

## MiniLED™ OEM without module

with a handpiece, a Ø7.5mm opalescent guide, an oval light shield and with:  
Medium grey cord  
Dark grey cord

**F02693**

**F02694**

## MiniLED™ OEM without module

with a handpiece, a module, a Ø7.5mm opalescent guide, an oval light shield and with:

Light grey cord	<b>F02714</b>
-----------------	---------------



Light grey

Medium grey

Dark grey

# miniled supercharged



## MiniLED™ Supercharged OEM handpiece

**F05218**

## MiniLED™ Supercharged OEM with module

with a handpiece, a module, a Ø7.5mm opalescent guide, an oval light shield and with:

Light grey cord	<b>F05205</b>
Medium grey cord	<b>F05206</b>
Dark grey cord	<b>F05207</b>
Surf 6 grey cord	<b>F05208</b>



Light grey

Medium grey

Dark grey



## Module



MiniLED™ OEM module

F02730

## Cords



Dark grey cord

F02721



Medium grey cord

F02722



Light grey cord

F02723

Surf 6 grey cord

F02326

Grey 3 (Medium grey) cord

F02327

## Light guides



Opalescent light guide Ø7.5mm

F02648



Opalescent light guide Ø5.5mm

F02652



Opalescent amber light guide Ø7.5mm

F02620

## Light shield & caps



Oval light shield  
for MiniLED™ Supercharged OEM

F05407



Oval light shield  
for MiniLED™ OEM

F02555



Autoclavable caps Ø7.5mm x5  
for MiniLED™ OEM,  
MiniLED™ Supercharged OEM

F61507



Autoclavable caps Ø5.5mm x5  
for MiniLED™ OEM,  
MiniLED™ Supercharged OEM

F61505



Autoclavable caps Ø7.5mm x5  
Autoclavable caps Ø5.5mm x5  
for MiniLED™ OEM,  
MiniLED™ Supercharged OEM

F61515

# INTRAORAL CAMERAS

.....

<b>Module &amp; linking cables dock U</b>	<b>340</b>
Linking cables dock U	341
<b>Configuration of docks U</b>	<b>343</b>
Linking cables dock MU USB2	344

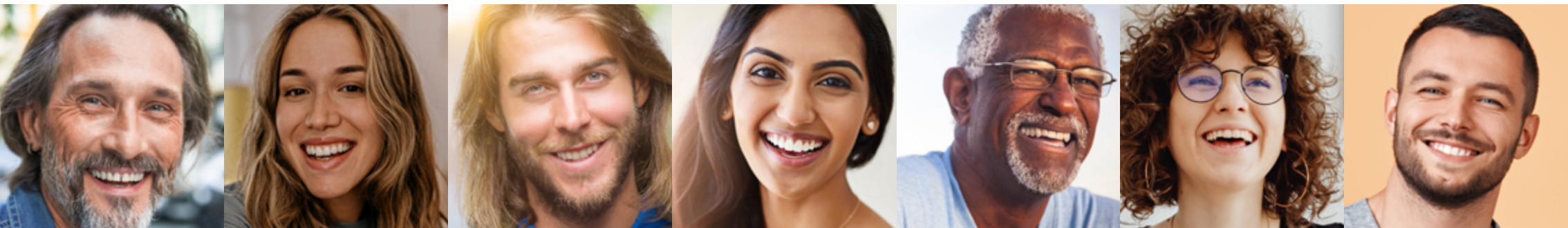

## Module & linking cables dock U



**Mini Dock U USB2<sup>(1)</sup>**  
Built-in docking station with USB2 output

**MINI DOCK  
U\_USB2**

Linking cables for built-in docking stations type U without sheath Length 2.5m	922144
Linking cables for built-in docking stations type U without sheath Length 5m	922145
Linking cables for built-in docking stations type U without sheath Length 7m	922146
Linking cables for built-in docking stations type MU without sheath Length 2.5m	922062
Linking cables for built-in docking stations type MU without sheath Length 5m	922063
Linking cables for built-in docking stations type MU without sheath Length 7m	922064

## Linking cables dock U

Linking cable light grey instrument holder Length 2.5m	922147
Linking cable light grey instrument holder Length 5m	922148
Linking cable light grey instrument holder Length 7m	922149
Linking cable light grey Cattani Ø21 suction holder Length 5m	922150
Linking cable light grey UK pending cord holder Length 2.5m	922151
Linking cable light grey UK pending cord holder Length 5m	922152
Linking cable light grey UK pending cord holder Length 7m	922153
Linking cable Surf 6 instrument holder Length 2.5m	922154
Linking cable Surf 6 instrument holder Length 5m	922155
Linking cable Surf 6 instrument holder Length 7m	922156
Linking cable Surf 6 Cattani Ø21 suction holder Length 2.5m	922157
Linking cable Surf 6 Cattani Ø21 suction holder Length 5m	922158
Linking cable Surf 6 Cattani Ø21 suction holder Length 7m	922159
Linking cable Surf 6 UK pending cord holder Length 2.5m	922138
Linking cable Surf 6 UK pending cord holder Length 5mWw	922160
Linking cable Surf 6 UK pending cord holder Length 7m	922139

(1) Mini Dock U USB2 : Built-in docking station with USB2 output.  
Class I medical devices - CE - Manufacturer: Sopro ACTEON® Group - France

## Linking cables dock U

Linking cable grey 3 UK pending cord holder Length 2m	922140
Linking cable grey 3 UK pending cord holder Length 7m	922141
Linking cable dark grey instrument holder Length 2.5m	922161
Linking cable dark grey instrument holder Length 5m	922162
Linking cable dark grey instrument holder Length 7m	922163
Linking cable dark grey Cattani Ø21 suction holder Length 2.5m	922164
Linking cable dark grey Cattani Ø21 suction holder Length 5m	922165
Linking cable dark grey UK pending cord holder Length 7m	922166
Linking cable medium grey instrument holder Length 2.5m	922167
Linking cable medium grey instrument holder Length 5m	922168
Linking cable medium grey instrument holder Length 7m	922143
Linking cable medium grey Cattani Ø21 suction holder Length 5m	922142

## Configuration of docks U

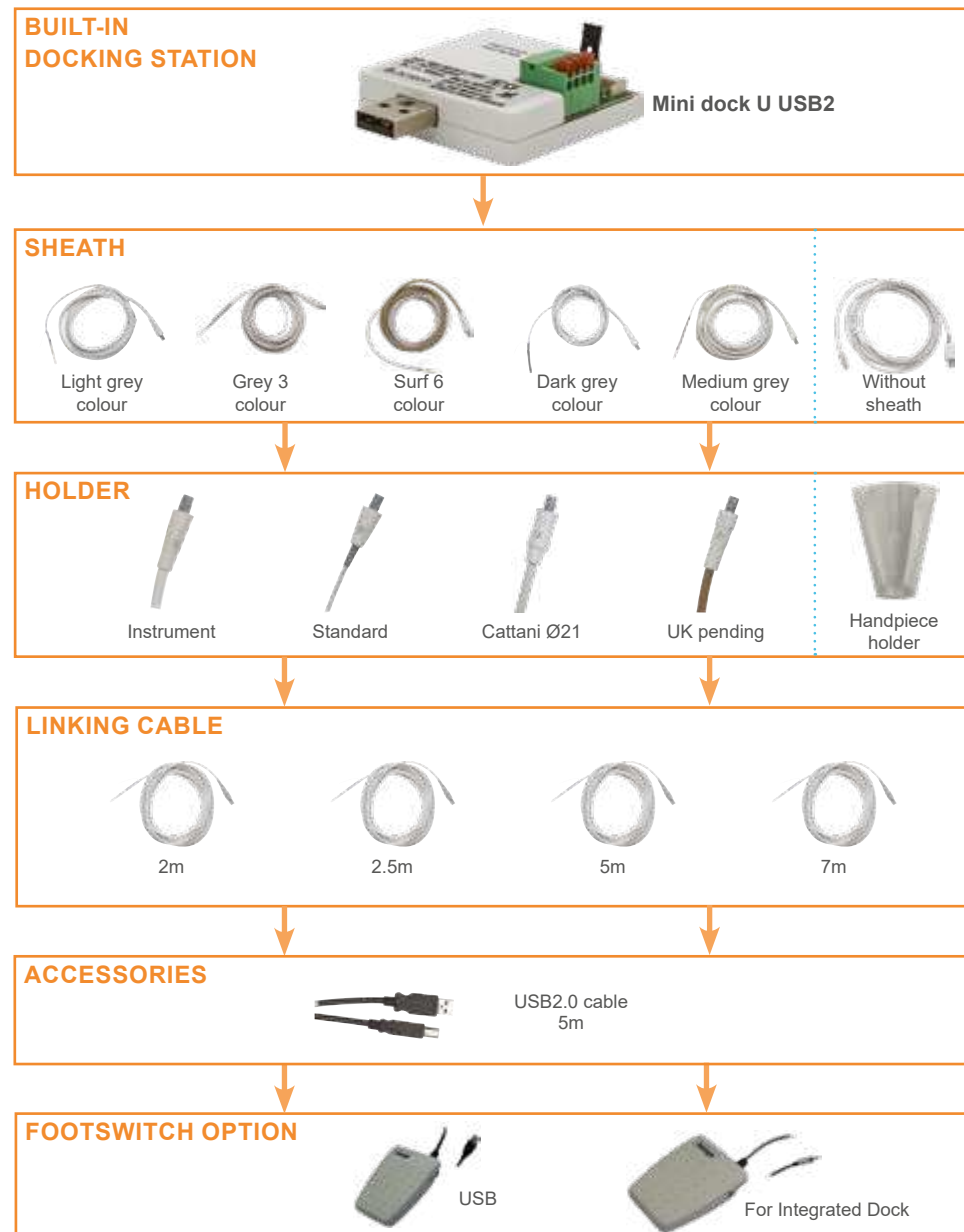

## Linking cables dock MU USB2

Linking cable light grey instrument holder Length 2.5m	922065
Linking cable light grey instrument holder Length 5m	922066
Linking cable light grey instrument holder Length 7m	922067
Linking cable light grey Cattani Ø21 suction holder Length 5m	922075
Linking cable light grey UK pending cord holder Length 2.5m	922086
Linking cable light grey UK pending cord holder Length 5m	922087
Linking cable light grey UK pending cord holder Length 7m	922088
Linking cable Surf 6 instrument holder Length 2.5m	922098
Linking cable Surf 6 instrument holder Length 5m	922099
Linking cable Surf 6 instrument holder Length 7m	922100
Linking cable Surf 6 Cattani Ø21 suction holder Length 2.5m	922101
Linking cable Surf 6 Cattani Ø21 suction holder Length 5m	922102
Linking cable Surf 6 Cattani Ø21 suction holder Length 7m	922103
Linking cable Surf 6 UK pending cord holder Length 2.5m	922104
Linking cable Surf 6 UK pending cord holder Length 5mWw	922105
Linking cable Surf 6 UK pending cord holder Length 7m	922106

Linking cable grey 3 UK pending cord holder Length 2m	922126
Linking cable grey 3 UK pending cord holder Length 7m	922127
Linking cable dark grey instrument holder Length 2.5m	922068
Linking cable dark grey instrument holder Length 5m	922069
Linking cable dark grey instrument holder Length 7m	922070
Linking cable dark grey Cattani Ø21 suction holder Length 2.5m	922080
Linking cable dark grey Cattani Ø21 suction holder Length 5m	922081
Linking cable dark grey UK pending cord holder Length 7m	922094
Linking cable medium grey instrument holder Length 2.5m	922071
Linking cable medium grey instrument holder Length 5m	922072
Linking cable medium grey instrument holder Length 7m	922073
Linking cable medium grey Cattani Ø21 suction holder Length 5m	922084



---

# **ACTEON® OEM**

<b>ACTEON® CONTACTS</b>	<b>348</b>
<b>ALPHABETICAL INDEX OF PRODUCTS</b>	<b>350</b>
<b>LEGAL INFORMATIONS</b>	<b>354</b>

**ACTEON EQUIPMENT & ACTEON PHARMA - FRANCE**

17, av. Gustave Eiffel ■ ZI du Phare ■ 33700 MERIGNAC ■ FRANCE  
 Tel.: +33 (0) 556 340 607 ■ Fax: +33 (0) 556 349 292 ■ info@acteongroup.com

**ACTEON IMAGING - FRANCE**

ZAC Athélie IV ■ Avenue des Genévriers ■ 13705 LA CIOTAT cedex ■ FRANCE  
 Tel.: +33 (0) 442 980 101 ■ Fax: +33 (0) 442 717 690 ■ info.sop@acteongroup.com

**ACTEON AUSTRALIA / NEW ZEALAND**

Suite 1 ■ 13B Narabang Way ■ Belrose, NSW 2085 ■ AUSTRALIA  
 Tel.: +612 9669 2292 ■ acteon.anz.admin@acteongroup.com

**ACTEON BRAZIL - MICRO IMAGEM**

Alameda Venus 233 ■ D.I American Park ■ INDAIATUBA, SAO PAULO ■ CEP 13347-659 ■ BRAZIL  
 Tel.: +19 3936 8090 ■ paulo.brienza@acteongroup.com

**ACTEON CHINA**

Office 1615 ■ NanYin Building, No 2 ■ North East Third Ring Road ■ Chaoyang District  
 BEIJING 100027 ■ CHINA  
 Tel.: +86 10 646 57011 ■ info.cn@acteongroup.com

**ACTEON GERMANY**

Klaus-Bungert-Str. 5 ■ 40468 DÜSSELDORF ■ GERMANY  
 Tel.: +49 211 169800-0 ■ Fax: +49 211 169800-48 ■ info.de@acteongroup.com

**ACTEON IBERICA**

Avda Principal n° 11H ■ Poligono Industrial Can Clapers  
 08181 SENTMENAT (BARCELONE) ■ SPAIN  
 Tel.: +34 93 715 45 20 ■ Fax: +34 93 715 32 29 ■ info.es@acteongroup.com

**ACTEON INDIA**

B-94, GIDC Electronic Estate ■ Sector 25 ■ GANDHINAGAR 382023 ■ GUJARAT - INDIA  
 Tel.: +91 1147018291 ■ Fax: +91 079-23287473 ■ info@in.acteongroup.com

**ACTEON ITALIA**

Via Roma 45 ■ 21057 OLGiate OLONA (VARESE) ■ ITALY  
 Tel.: +39 0331 376 760 ■ Fax: +39 0331 376 763 ■ info.it@acteongroup.com

**ACTEON LATIN AMERICA**

Puebla ■ MEXICO  
 Tel.: +34 93 715 45 20 ■ Fax: +34 93 715 32 29 ■ acteon.latam@acteongroup.com

**ACTEON MIDDLE EAST**

247 Wasfi Al Tal Str. ■ 401 AMMAN ■ JORDANIA  
 Tel.: +962 6 553 4401 ■ Fax: +962 6 553 7833 ■ info.me@acteongroup.com

**ACTEON NORTH AMERICA**

124 Gaither Drive ■ Suite 140 ■ MOUNT LAUREL NJ 08054 ■ UNITED STATES  
 Tel.: +1 856 222 9988 ■ Fax: +1 856 222 4726 ■ info.us@acteongroup.com

**ACTEON RUSSIA**

Gilyarovskogo Str. ■ 6b1, off 212 ■ 129090 MOSCOW ■ RUSSIA  
 Tel.: +7 926 233 1695 ■ Fax: +7 495 150 1323 ■ info.ru@acteongroup.com

**ACTEON TAIWAN**

Walsin Xinyi Building ■ 11F, 1 Songzhi Road ■ TAIPEI 11047 ■ TAIWAN  
 Tel.: +886 2 8729 2111 ■ info.tw@acteongroup.com

**ACTEON THAILAND**

23/65 Sorachai Building ■ 18<sup>th</sup> Floor ■ Sukumvit 63 Road ■ Klongton Nua ■ Wattana,  
 BANGKOK 10110 ■ THAILAND  
 Tel.: +66 2 714 3295 ■ Fax: +66 2 714 3296 ■ info.th@acteongroup.com

**ACTEON TURKEY**

Barbaros Mah. Dereboyu Cad ■ Akzambak Sokak Uphill Towers ■ B Blok K14 D84 Atasehir ISTANBUL  
 34746 ■ TURKEY  
 Tel.: +90 532 481 20 57 ■ talha.gonca@acteongroup.com

**ACTEON UK**

Acteon House ■ Phoenix park ■ Eaton Socon ■ ST NEOTS PE19 8EP ■ ENGLAND  
 Tel.: +44 1480 477 307 ■ Fax: +44 1480 477 381 ■ info.uk@acteongroup.com

<b>A</b>		
ABF - Anti-mist solution for mirrors	179	
Air Max	133	
Air Max - Accessories	134	
AIR-N-GO® - Accessories	131	
AIR-N-GO® easy	128	
AIR-N-GO® easy - Adapters	130	
AIR-N-GO® easy - Nozzles	129	
AIRHOLY®	253	
AIS	30	
Alginate mixer	246	
Amalgam & composite instruments	189	
Apical Surgery tips	108	
<b>B</b>		
Bliss® Diagnostic instruments	164	
Bliss® Dual Ends instruments	163	
Bliss® Endodontic instruments	166	
Bliss® Gracey curettes	162	
Bliss® Kits	160	
Bliss® Mirror handle	167	
Bliss® Periodontic instruments	164	
Bliss® Restoration instruments	165	
Bliss® Sickles instruments	162	
Bliss® Universal curettes	163	
Bone curette	239	
Bone Surgery tips	84	
<b>C</b>		
C50	60	
Cameras - Accessories	68	
Cameras - Docking stations	66	
Cameras - OEM module	340	
Cameras - OEM linking cables	340	
CAV-Hycal™	276	
Cement spatulas	191	
CHROMALG'X™	284	
Cimavit™	299	
Cimavit™ Photo	300	
Cocoon Hygienist LED - Accessories	149	
Conventional tips	104	
Coolsin™ Plus	276	
Cortisolol™ SP	298	
Crest Splitting tips	89	
Crown Extension tips	88	
Curettes - Extraction instruments	222	
Curodont™ Repair	288	
<b>D</b>		
Dental Silk Sutures	311	
Desocclusol™ Orange	300	
<b>E</b>		
Elevators - Extraction instruments	213	
Elevators - Implantology instruments	240	
Elevator - Dr Roos	199	
Elevators - Kopp	214	
Elevators luxators	212	
Elevators - Removal blades	212	
EndoCenter - Accessories	152	
Endodontic supports	251	
EndoDual - Accessories	152	
Endosuccess™ Apical Surgery tips	109	
Endosuccess™ Canal Access Prep tips	110	
Endosuccess™ Retreatment tips	109	
Endosurgery Essential kit	204	
Endosurgery Instruments	205	
Endosurgery Surgery kit	204	
Endosurgery tips	108	
Etik™ Collagene	308	
Eugenol Pur	298	
Examination sets - Diagnostic instruments	182	
EXPASYL™	274	
EXPASYL™ Exact	274	
Extraction tips	87	
<b>F</b>		
Forceps - Adult	216	
Forceps - Child	221	
Forceps - Surgery instruments	229	
Forceps - Syndesmotome	220	
Friljet™	307	
<b>G</b>		
GingiProtect®	190	
Gingival retraction & burnisher instruments	191	
<b>H</b>		
Handpieces - OEM	324	
HT-Implant - Accessories	92	
Hemostasy™	309	
HYCAL™	297	

<b>I</b>		
I-Surge™ - Accessories	82	
I-Surge™ + - Accessories	82	
Implant Center 2	80	
Implant Remover kit	242	
Implant Protect tips	105	
Impression trays	194	
Intralift™ tips	86	
IrriFlex®	294	
Irrisafe tips	107	
<b>K</b>		
Kite Surf™ Basic Light	282	
Kite Surf™ Heavy XL	281	
Kite Surf™ Light	283	
Kite Surf™ Occlusion	283	
Kite Surf™ Putty Soft	280	
Kite Surf™ Putty Soft XL	280	
Kite Surf™ Regular	281	
<b>M</b>		
Mallet	239	
MiniLED™ - Accessories	143	
MiniLED™ Active	139	
MiniLED™ - OEM accessories	143	
MiniLED™ - OEM cords	336	
MiniLED™ - OEM module	336	
MiniLED™ Ortho 2	141	
MiniLED™ Standard	142	
MiniLED™ Standard - OEM	334	
MiniLED™ Supercharged	140	
MiniLED™ Supercharged - OEM	335	
Micromirrors CSS	178	
Micromirrors SS	175	
Mirrors - Handles	179	
Mirrors - Mouth mirrors CSS	178	
Mirrors - Mouth mirrors SS	172	
Mirrors - Photographic & contrastors	176	
Mirrors - Top range	174	
Motors - OEM cords	331	
Motors - OEM	330	
Motors - OEM Modules	330	
MTA* CAPS™	297	
<b>N</b>		
Needle-holders - Implantology instruments	238	
Needle-holders - Surgery instruments	230	
NEWTRON® Booster	102	
NEWTRON® P5	101	
NEWTRON® P5XS	100	
NEWTRON® Range I - Accessories	122	
NEWTRON® Range II - Accessories	120	
NEWTRON® Range III - Accessories	118	
NEWTRON® Range IV - Accessories	116	
<b>O</b>		
Orthodontic instruments	247	
ORTHOFAST™	284	
Osteotomes - Angulated concave	235	
Osteotomes - Angulated convex	234	
<b>P</b>		
Perfect Margin® Rounded tips	110	
Perio Maintenance tips	106	
Perio Precision tips	106	
Periodontic tips	105	
Periofine tips	104	
PerioSoft tips	106	
Piezocision™ tips	90	
PIEZOTOME® - Accessories	82	
PIEZOTOME® Cube	78	
Pilars instrument	239	
Pliers - Orthodontic instruments	247	
Powders - AIR-N-GO® Classic	135	
Powders - AIR-N-GO® Perio	135	
PR BOND™	277	
PR ETCH™	278	
PR SCELL™ Glass Ionomer	277	
PRALG'X™	285	
Primacaïne™ Adrenaline 1/100 000	306	
Primacaïne™ Adrenaline 1/200 000	306	
Probes - Diagnosis instruments	184	
Probes (graduated) - Periodontic instruments	199	
ProphyMax™	132	
ProphyMax™ - Accessories	134	
Prosthesis instruments	195	
Prosthesis tips	111	
Protorch 4	253	
PSPIX®2	44	
PSPIX®2 - Accessories	45	



<b>Q</b>			
Quaz - Accessories	150	<b>T</b>	
QUICK'N POST™	279	Tip kits	112
		Trans'Care - Accessories	149
<b>R</b>		Trays	251
Retractors	237	Tweezers - Diagnostic instruments	183
Retreatment tips	108	Tweezers - Implantology instruments	241
Rings - LED - OEM	325	Tweezers - Surgery instruments	228
RISKONTROL® Adapters	262		
RISKONTROL® Art	260	<b>U</b>	
RISKONTROL® Classic	261	Ultrasonic cleaners	252
RISKONTROL® Sterile	261	U-SENSE	56
RISKONTROL® Total Protec	260	U-SENSE HD	56
		Ultrasonic files	107
<b>S</b>		Ultrasonic OEM - Accessories	327
SALVIZOL™ E.D.T.A.	296	Ultrasonic OEM - Cords	322
Scaler - Periodontic instruments	198	Ultrasonic OEM - Handpieces	324
Scaling tips	104	Ultrasonic OEM - Rings	325
Scalpels	231		
Scissors - Surgery instruments	227	<b>V</b>	
Scissors - Implantology instruments	238	Vela 170 - Accessories	152
Scissors - Goldman Fox	226		
Scissors - Metzenbaum	227	<b>W</b>	
Sealing spatulas & modelling	188	Wrenches	115
Sealite™ Regular	299		
SEPTOL™ Aspiration	264	<b>X</b>	
SEPTOL™ Empreinte	267	X-MIND® DC	38
SEPTOL™ Instruments enzymatic	266	X-MIND® DC - Accessories & Spare parts	40
SEPTOL™ Rotative	265	X-MIND® Prime 2 - Spare parts	22
SEPTOL™ Savon doux	268	X-MIND® Prime 2 Pan 2D	18
SEPTOL™ Spray	269	X-MIND® Prime 2 Pan 2D CEPH	19
SERVOTOME®	94	X-MIND® Prime 2 Pan 3D	20
SERVOTOME® - Electrodes	95	X-MIND® Prime 2 Pan 3D CEPH	21
Sinus Lift tips	85	X-MIND® Trium - Accessories & Spare parts	28
Sitsalicine™	291	X-MIND® Trium TLD Pan 3D	26
Surgery tips	84	X-MIND® Trium TLD Pan 3D CEPH	27
Softly	148	X-MIND® Unity	34
SOPIX®	54	X-MIND® Unity - Accessories & Spare parts	36
SOPIX®2	54	Xylorlland™ sans vasoconstricteur	307
SOPIX® Plug-in	52		
SOPIX®2 Plug-in	53		
SOPRO® 617	64		
SOPROCARE®	62		
SP4055 NEWTRON®	320		
SP NEWTRON®	316		
SP NEWTRON® LED	318		
Sterile Dental Needles	310		
Sterilization cassettes	250		
Syndesmotomes	211		
Syndesmotomes - Dr Bernard	210		



**PRIMACAÏNE™****adrénaline 1/100 000****1- DENOMINATION OF THE MEDICINAL PRODUCT**

PRIMACAÏNE ADRENALINE  
1/100 000, injectable solution for dental use.

**2- QUALITATIVE AND****QUANTITATIVE COMPOSITION**

Articaine 60.277 mg  
in the form of articaine hydrochloride  
Adrenaline 0.017 mg  
in the form of adrenaline tartrate  
for one cartridge of 1.7 ml.  
Excipient with a known effect: sodium metabisulphite  
For the complete list of excipients, see section 6.1.

**3- PHARMACEUTICAL FORM**

Injectable solution for dental use.

**4- CLINICAL DATA****4.1 Therapeutic indications**

Local or loco-regional anaesthesia in odonto-stomatological practice.  
This presentation is particularly adapted when procedures require a high ischemia.

**4.2 Dose and mode of administration**

Reserved for adult and child over 4 as this type of anaesthesia is unsuitable before this age.

**Dose****Adult**

The quantity to be injected will be adapted according to the importance of the intervention.  
Usually, half to one cartridge for a common procedure.

Do not exceed the dose of 7mg of articaine hydrochloride per kilogram of bodyweight.

**Elderly subject**

Administer half of the dose indicated for adults.

**Pediatric population****Child (over 4)**

The quantity to be injected depends on the child's age, weight and the type of procedure performed.

The maximal dose to expect is 5mg of articaine hydrochloride (0.125ml of anaesthetic solution) per kilogram of bodyweight.

The mean dose in mg of articaine hydrochloride that can be administered in a child can be calculated as follow:  
Child's weight (in kilograms) x 1.33

**Mode of administration**

LOCAL OR REGIONAL INTRA-ORAL SUBMUCOSAL INJECTION.

Verify the absence of vascular effraction

by repeated aspiration tests, particularly during regional anaesthesia (nerve blocks).

The injection rate must not exceed 1ml of solution per minute.

**4.3 Contraindications**

This medicinal product is contraindicated in the case of hypersensitivity to local anaesthetics or to any of the constituents, and in the following situations:

- Severe disorders of atrioventricular conduction without a pacemaker.
- Epilepsy not controlled by treatment.
- Porphyria.

This medicine is usually unadvised in association with sibutramine (see section 4.5).

**4.4 Special warnings and precautions for use****Special warnings**

THIS PRODUCT CONTAINS  
1/100 000 ADRENALINE.

Take the risk of local necrosis into account in hypertensive or diabetic subjects.

Anaesthesiophagy risks: all kind of bites (lips, cheeks, mucous, tongue); advise patients to avoid the use of chewing gum or eating food as long as the insensibility persists.

Avoid injection into infected and inflamed areas (decreased efficacy of the local anaesthetic).  
Sportsmen will be advised that this medicinal product contains an active substance that can cause a positive reaction on anti-doping control tests.

**Pediatric population**

The use of this product is not recommended in children under the age of 4 years, as this type of anaesthesia is unsuitable before this age.

**Precautions for use**

The use of this product requires imperatively:

- to conduct a clinical interview to determine the clinical context, concomitant treatments and the patient's history,
- to perform a test injection of 5 to 10% of the dose in case of allergic risk,
- to perform the injection slowly and strictly outside of the vessels, verifying by repeated aspirations,
- to maintain verbal contact with the patient.

Increased surveillance is required in subjects treated with anticoagulants (surveillance of the INR).

Due to the presence of adrenaline,

precautions and increased surveillance in case of:

- all rhythm abnormalities, except bradycardia;
- coronary insufficiency;
- severe arterial hypertension.

The dose of articaine may need to be decreased in case of severe hepatic insufficiency, due to the mainly hepatic metabolism of amide local anaesthetics.  
The dosage must also be decreased in case of hypoxia, hyperkalaemia or metabolic acidosis.

The simultaneous administration of this anaesthetic with some products (see section 4.5) requires a close monitoring of the patient's clinical and biological state.

**4.5 Interactions with other drugs or other interactions****Association not recommended**

Due to the presence of adrenaline:

**+ Sibutramine:** Paroxystic hypertension with possibility of rhythm abnormalities (inhibition of the adrenaline or nor-adrenaline's entrance in the sympathetic fibre).

**Associations with precautions for use**

Due to the presence of adrenaline:

**+ Halogenated volatile anaesthetics:** Serious ventricular rhythm abnormalities (increase of the cardiac reactivity). Limit the dose, for example: less than 0.1mg of adrenaline in 10 minutes or 0.3mg in one hour in adult.

**+ Imipraminic anti-depressors:**

Paroxystic hypertension with possibility of rhythm abnormalities (inhibition of the adrenaline or nor-adrenaline's entrance in the sympathetic fibre). Limit the dose, for example: less than 0.1mg of adrenaline in 10 minutes or 0.3mg in one hour in adult.

**+ Serotonergic-noradrenergic anti-depressors (described for minalcipran and venlafaxine):**

Paroxystic hypertension with possibility of rhythm abnormalities (inhibition of the adrenaline or nor-adrenaline's entrance in the sympathetic fibre). Limit the dose, for example: less than 0.1mg of adrenaline in 10 minutes or 0.3mg in one hour in adult.

**+ Non selective MAOI (iproniazide):**

Increase of the adrenaline and nor-adrenaline's pressive action, more often moderated. Use only under strict medicinal control.

**+ "A" Selective MAOI (moclobemide, toloxatone) by extrapolation from the**

**non selective MAOI:** Risk of increase of the pressive action. Use only under strict medicinal control.

**Associations to take into account**

**+ Guanethidine:** High increase of the blood pressure (hyper reactivity due to the reduction of the sympathetic tonus and/or to the inhibition of the adrenaline or nor-adrenaline's entrance in the sympathetic fibre).

**4.6 Fertility, pregnancy and breastfeeding****Pregnancy**

The studies carried out on animals do not show any teratogenic effect.  
Due to the absence of teratogenic effect on mankind is not expected. Indeed, until today, the substances responsible of malformations on mankind have been teratogenics on animals during studies carried out on two species.  
In clinical practice, there are actually not enough relevant facts to estimate an eventual malformative or foetotoxic effect of the articaine when administered during pregnancy.

Consequently, the use of articaine can be prescribed for odonto-stomatology indications during pregnancy, only if necessary.

**Breastfeeding**

Like other local anaesthetics, articaine diffuses into breast milk in very small quantities; however, breastfeeding can be continued following the anaesthetic procedure.

**4.7 Effects on ability to drive and use machines**

PRIMACAÏNE ADRENALINE  
1/100 000 has a moderate influence on the ability to drive and use machines.

**4.8 Side effects**

Like with all the anaesthetics used in odonto-stomatology, lipothymies can happen.

This product contains sodium metabisulphite, which can involve or worsen anaphylactic reactions and bronchospasms.

In the case of overdose or in certain predisposed patients, the following clinical signs may be observed:

- **on the central nervous system:** nervousness, agitation, yawning, tremor, apprehension, nystagmus, logorrhoea, headache, nausea, ringing in the ears. In the presence of these warning signs, the patient must be asked to hyperventilate, and attentive surveillance is required to prevent

possible deterioration with seizures followed by CNS depression.

- **on the respiratory system:** tachypnoea, then bradypnoea, possibly leading to apnoea.

- **on the cardiovascular system:** tachycardia, bradycardia, cardiovascular depression with arterial hypotension, possibly leading to collapse, arrhythmias (premature ventricular complexes, ventricular fibrillation), disorders of conduction (atrioventricular block).

These cardiac manifestations can lead to cardiac arrest.

**Reporting of suspected side effects**

The reporting of suspected side effects after approval of the medicinal product is important. It allows continuous monitoring of the benefit/risk ratio of the medicinal product.

Health professionals declare any suspected side effects through the national reporting system.

**4.9 Overdose**

Toxic reactions, reflecting overdose of local anaesthetic, can occur in two situations: either immediately, due to relative overdose resulting from accidental intravenous injection, or more delayed, corresponding to true overdose due to the use of an excessive quantity of anaesthetic.

**Action in case of overdose**

As soon as warning signs are observed, ask the patient to hyperventilate, place the patient in the supine position, when necessary. In the case of clonic seizures, oxygenation injection of a benzodiazepine.

Treatment may require intubation with assisted ventilation.

**5- PHARMACOLOGICAL PROPERTIES****5.1 Pharmacodynamic properties**

Pharmacotherapeutic class: **LOCAL**

**ANAESTHETICS,**

ATC Code: **N01BB58**

**Mechanism of action**

Articaine hydrochloride is an amide local anaesthetic, which blocks propagation of the nerve impulse along the nerve fibre at the site of injection.

The addition of adrenaline (diluted at 1/100 000) to the solution of articaine delays the passage of the articaine into the systemic circulation and maintains an active tissue concentration, allowing to obtain a little hemorrhagic operative field.

Anaesthesia is obtained within 2 to 3

minutes. The duration of anaesthesia allowing the surgical procedure is about 60 minutes. It is 2 to 3 times shorter for pulpar anaesthesia.

**5.2 Pharmacokinetic properties****Distribution**

When injected into the oral mucosa, articaine reaches its peak blood concentration about 30 minutes after injection.

**Elimination**

The mean elimination half-life of articaine hydrochloride is about 110 minutes.

Articaine hydrochloride is mainly metabolised in the liver; 5 to 10% of the dose are eliminated under unchanged form in the urine.

**5.3 Preclinical safety data**

Studies carried out on animals have demonstrated the good tolerance of articaine.

Like other amide local anaesthetics, high doses of the active substance can induce toxic reactions on the central nervous system and/or on the cardiovascular system (see section 4.8).

**6- PHARMACEUTICAL DATA****6.1 List of excipients**

Sodium chloride, sodium metabisulphite, hydrochloride acid, sodium hydroxide, water for injections.

**6.2 Incompatibilities**

In the absence of compatibility studies, this medicinal product should not be mixed with other medicinal products.

**6.3 Shelf life**

Before opening: 2 years.

After opening: the product must be used immediately.

**6.4 Special storage precautions**

Store at a temperature not exceeding + 25°C.

Store cartridges in the external packaging, away from light.

**6.5 Nature and content of external packing**

1.7ml in cartridge (type I colourless glass) with a stopper (bromobutyl) and capsule (aluminium) with joint (bromobutyl). Box of 50.

**6.6 Special precautions for disposal and handling**

Like for all cartridges, the diaphragm will be disinfected just before use. It will be carefully plugged:

- either with ethyl alcohol at 70%,
- or with pure isopropyl alcohol at 90% for pharmaceutical use.

The cartridges must never be plunged in

any solution.

Do not mix the injectable solution with other products in the same syringe. Any opened cartridge of anaesthetic solution must not be re-used.

#### 7- HOLDER OF THE MARKETING AUTHORIZATION

PRODUITS DENTAIRE PIERRE ROLLAND

ZI du Phare - 17 avenue Gustave Eiffel - 33700 MERIGNAC

#### 8- FRENCH REGISTRATION ID NUMBER

CIP 34009 564 696 5 9: 1.7ml in cartridge (glass) with a stopper (bromobutyl); box of 50.

#### 9- DATE OF FIRST

#### AUTHORIZATION/OF RENEWAL OF THE AUTHORIZATION IN FRANCE

Date of first authorization:

24<sup>th</sup> December 2002

Date of last renewal:

24<sup>th</sup> December 2012

#### 10- DATE OF TEXT UP-DATING IN FRANCE

24<sup>th</sup> January 2019

#### CONDITIONS OF PRESCRIPTION AND DELIVERY IN FRANCE

List I.

Medicinal product reserved for professional use according to article R.5121-80 of the French public health code.

#### PRIMACAÏNE™

#### adrénaline 1/200 000

#### 1- DENOMINATION OF THE MEDICINAL PRODUCT

PRIMACAÏNE ADRENALINE 1/200 000, injectable solution for dental use.

#### 2- QUALITATIVE AND QUANTITATIVE COMPOSITION

Articaïne 60.277 mg in the form of articaïne hydrochloride  
Adrenaline 0.0085 mg in the form of adrenaline tartrate for one cartridge of 1.7 ml.  
Excipient with a known effect: sodium metabisulphite

For the complete list of excipients, see section 6.1.

#### 3- PHARMACEUTICAL FORM

Injectable solution for dental use.

#### 4- CLINICAL DATA

##### 4.1 Therapeutic indications

Local or loco-regional anaesthesia in odonto-stomatological practice.

##### 4.2 Dose and mode of administration

Reserved for adult and child over 4 as this type of anaesthesia is unsuitable before this age.

##### Dose

##### Adult

The quantity to be injected will be adapted according to the importance of the intervention.

Usually, half to one cartridge for a common procedure.

Do not exceed the dose of 7mg of articaïne hydrochloride per kilogram of bodyweight.

##### Elderly subject

Administer half of the dose indicated for adults.

##### Pediatric population

##### Child (over 4)

The quantity to be injected depends on the child's age, weight and the type of procedure performed.

The maximal dose to expect is 5mg of articaïne hydrochloride (0.125ml of anaesthetic solution) per kilogram of bodyweight.

The mean dose in mg of articaïne hydrochloride that can be administered in a child can be calculated as follows:  
Child's weight (in kilograms) x 1.33

##### Mode of administration

LOCAL OR REGIONAL INTRA-ORAL SUBMUCOSAL INJECTION.

Verify the absence of vascular effraction by repeated aspiration tests, particularly during regional anaesthesia (nerve blocks).

The injection rate must not exceed 1ml of solution per minute.

#### 4.3 Contraindications

This medicinal product is contraindicated in the case of hypersensitivity to local anaesthetics or to any of the constituents, and in the following situations:

- Severe disorders of atrioventricular conduction without a pacemaker.
- Epilepsy not controlled by treatment
- Porphyria.

This medicine is usually unadvised in association with sibutramine (see section 4.5).

#### 4.4 Special warnings and precautions for use

##### Special warnings

THIS PRODUCT CONTAINS

1/200 000 ADRENALINE.

Take the risk of local necrosis into account in hypertensive or diabetic subjects.

Anaesthesiophagy risks: all kind of bites (lips, cheeks, mucous, tongue); advise patients to avoid the use of chewing gum or eating food as long as the insensibility persists.

Avoid injection into infected and inflamed areas (decreased efficacy of the local anaesthetic).

Sportsmen will be advised that this medicinal product contains an active substance that can cause a positive reaction on anti-doping control tests.

##### Pediatric population

The use of this product is not recommended in children under the age of 4 years, as this type of anaesthesia is unsuitable before this age.

##### Precautions for use

The use of this product requires imperatively:

- to conduct a clinical interview to determine the clinical context, concomitant treatments and the patient's history,
- to perform a test injection of 5 to 10% of the dose in case of allergic risk,
- to perform the injection slowly and strictly outside of the vessels, verifying by repeated aspirations,
- to maintain verbal contact with the patient.

Increased surveillance is required in subjects treated with anticoagulants (surveillance of the INR).

Due to the presence of adrenaline, precautions and increased surveillance in case of:

- all rhythm abnormalities, except

bradycardia;

- coronary insufficiency;
- severe arterial hypertension.

The dose of articaïne may need to be decreased in case of severe hepatic insufficiency, due to the mainly hepatic metabolism of amide local anaesthetics. The dosage must also be decreased in case of hypoxia, hyperkalaemia or metabolic acidosis.

The simultaneous administration of this anaesthetic with some products (see section 4.5) requires a close monitoring of the patient's clinical and biological state.

#### 4.5 Interactions with other drugs or other interactions

##### Associations not recommended

Due to the presence of adrenaline:

**+ Sibutramine:** Paroxystic hypertension with possibility of rhythm abnormalities (inhibition of the adrenaline or nor-adrenaline's entrance in the sympathetic fibre).

##### Association with precautions for use

Due to the presence of adrenaline:

**+ Halogenated volatile anaesthetics:** Serious ventricular rhythm abnormalities (increase of the cardiac reactivity). Limit the dose, for example: less than 0.1mg of adrenaline in 10 minutes or 0.3mg in one hour in adult.

##### + Imipraminic anti-depressors:

Paroxystic hypertension with possibility of rhythm abnormalities (inhibition of the adrenaline or nor-adrenaline's entrance in the sympathetic fibre).

Limit the dose, for example: less than 0.1mg of adrenaline in 10 minutes or 0.3mg in one hour in adult.

##### + Serotonergic-noradrenergic anti-depressors (described for

minalcipran and venlafaxine):

Paroxystic hypertension with possibility of rhythm abnormalities (inhibition of the adrenaline or nor-adrenaline's entrance in the sympathetic fibre). Limit the dose, for example: less than 0.1mg of adrenaline in 10 minutes or 0.3mg in one hour in adult.

##### + Non selective MAOI (iproniazide):

Increase of the adrenaline and nor-adrenaline's pressive action, more often moderated. Use only under strict medicinal control.

**+ "A" Selective MAOI (moclobemide, toloxatone) by extrapolation from the non selective MAOI:** Risk of increase of the pressive action. Use only under strict medicinal control.

##### Associations to take into account

**+ Guanethidine:** High increase of the blood pressure (hyper reactivity due to the reduction of the sympathetic tonus and/or to the inhibition of the adrenaline or nor-adrenaline's entrance in the sympathetic fibre).

#### 4.6 Fertility, pregnancy and breastfeeding

##### Pregnancy

The studies carried out on animals do not show any teratogenic effect.

Due to the absence of teratogenic effect on animals, a malformative effect on mankind is not expected. Indeed, until today, the substances responsible of malformations on mankind have been teratogenics on animals during studies carried out on two species.

In clinical practice, there are actually not enough relevant facts to estimate an eventual malformative or foetotoxic effect of the articaïne when administered during pregnancy.

Consequently, the use of articaïne can be prescribed for odonto-stomatology indications during pregnancy, only if necessary.

##### Breastfeeding

Like other local anaesthetics, articaïne diffuses into breast milk in very small quantities; however, breastfeeding can be continued following the anaesthetic procedure.

#### 4.7 Effects on ability to drive and use machines

PRIMACAÏNE ADRENALINE

1/200 000 has a moderate influence on the ability to drive and use machines.

#### 4.8 Side effects

Like with all the anaesthetics used in odonto-stomatology, lipothymies can happen.

This product contains sodium metabisulphite, which can involve or worsen anaphylactic reactions and bronchospasms.

In the case of overdose or in certain predisposed patients, the following clinical signs may be observed:

- on the central nervous system: nervousness, agitation, yawning, tremor, apprehension, nystagmus, logorrhoea, headache, nausea, ringing in the ears. In the presence of these warning signs, the patient must be asked to hyperventilate, and attentive surveillance is required to prevent possible deterioration with seizures followed by CNS depression.
- on the respiratory system: tachypnoea, then bradypnoea, possibly leading to

apnoea.

• on the cardiovascular system: tachycardia, bradycardia, cardiovascular depression with arterial hypotension, possibly leading to collapse, arrhythmias (premature ventricular complexes, ventricular fibrillation), disorders of conduction (atrioventricular block).

These cardiac manifestations can lead to cardiac arrest.

#### Reporting of suspected side effects

The reporting of suspected side effects after approval of the medicinal product is important. It allows continuous monitoring of the benefit/risk ratio of the medicinal product.

Health professionals declare any suspected side effects through the national reporting system.

#### 4.9 Overdose

Toxic reactions, reflecting overdose of local anaesthetic, can occur in two situations: either immediately, due to relative overdose resulting from accidental intravenous injection, or more delayed, corresponding to true overdose due to the use of an excessive quantity of anaesthetic.

##### Action in case of overdose

As soon as warning signs are observed, ask the patient to hyperventilate, place the patient in the supine position, when necessary. In the case of clonic seizures, oxygenation injection of a benzodiazepine.

Treatment may require intubation with assisted ventilation.

#### 5- PHARMACOLOGICAL PROPERTIES

**5.1 Pharmacodynamic properties**  
Pharmacotherapeutic class: **LOCAL ANAESTHETICS,**

ATC Code: **N01BB58**

##### Mechanism of action

Articaïne hydrochloride is an amide local anaesthetic, which blocks propagation of the nerve impulse along the nerve fibre at the site of injection.

The addition of adrenaline (diluted at 1/200 000) to the solution of articaïne delays the passage of the articaïne into the systemic circulation and maintains an active tissue concentration, allowing to obtain a little hemorrhagic operative field.

Anaesthesia is obtained within 2 to 3 minutes. The duration of anaesthesia allowing the surgical procedure is about 60 minutes.

It is 2 to 3 times shorter for pulpar anaesthesia.

### 5.2 Pharmacokinetic properties

#### Distribution

When injected into the oral mucosa, articaine reaches its peak blood concentration about 30 minutes after injection.

#### Elimination

The mean elimination half-life of articaine hydrochloride is about 110 minutes.

Articaine hydrochloride is mainly metabolised in the liver; 5 to 10% of the dose are eliminated under unchanged form in the urine.

### 5.3 Preclinical safety data

Studies carried out on animals have demonstrated the good tolerance of articaine. Like other amide local anaesthetics, high doses of the active substance can induce toxic reactions on the central nervous system and/or on the cardiovascular system (see section 4.8).

### 6- PHARMACEUTICAL DATA

#### 6.1 List of excipients

Sodium chloride, sodium metabisulphite, hydrochloric acid, sodium hydroxide, water for injections.

#### 6.2 Incompatibilities

In the absence of compatibility studies, this medicinal product should not be mixed with other medicinal products.

#### 6.3 Shelf life

Before opening: 2 years.

After opening: the product must be used immediately.

#### 6.4 Special storage precautions

Store at a temperature not exceeding + 25°C.

Store cartridges in the external packaging, away from light.

#### 6.5 Nature and content of external packing

1.7ml in cartridge (type I colourless glass) with a stopper (bromobutyl) and capsule (aluminium) with joint (bromobutyl). Box of 50.

### 6.6 Special precautions for disposal and handling

Like for all cartridges, the diaphragm must be disinfected just before use. It will be carefully plugged:

- either with ethyl alcohol at 70%,
- or with pure isopropyl alcohol at 90% for pharmaceutical use.

The cartridges must never be plunged in any solution.

Do not mix the injectable solution with other products in the same syringe.

Any opened cartridge of anaesthetic solution must not be re-used.

### 7- HOLDER OF THE MARKETING AUTHORIZATION

PRODUITS DENTAIRE PIERRE ROLLAND  
ZI du Phare - 17 avenue Gustave Eiffel - 33700 MERIGNAC

### 8- FRENCH REGISTRATION ID NUMBER

CIP 34009 564 697 1 0: 1.7ml in cartridge (glass) with a stopper (bromobutyl); box of 50.

### 9- DATE OF FIRST

#### AUTHORIZATION/OF RENEWAL OF THE AUTHORIZATION IN FRANCE

Date of first authorization:

24<sup>th</sup> December 2002

Date of last renewal:

24<sup>th</sup> December 2012

### 10- DATE OF TEXT UP-DATING IN FRANCE

12<sup>th</sup> February 2019

### CONDITIONS OF PRESCRIPTION AND DELIVERY IN FRANCE

List I.

Medicinal product reserved for professional use according to article R.5121-80 of the French public health code.

### XYLOROLLAND™

#### sans vasoconstricteur

### 1- DENOMINATION OF THE MEDICINAL PRODUCT

XYLOROLLAND SANS VASOCONSTRICTEUR, injectable solution for dental use.

### 2- QUANTITATIVE AND QUANTITATIVE COMPOSITION

Lidocaine hydrochloride 36,00000mg

for one cartridge containing 1.8ml.

The sodium metabisulphite content, expressed as sulphur anhydride, is 1.8mg per ampoule.

Excipient with a known effect: sodium metabisulphite

For the complete list of excipients, see section 6.1.

### 3- PHARMACEUTICAL FORM

Injectable solution for dental use.

### 4- CLINICAL DATA

#### 4.1 Therapeutic indications

Local or loco-regional anaesthesia in odonto-stomatological practice.

This preparation is particularly used when the administration of a vasoconstrictor is inadvisable.

#### 4.2 Dose and mode of administration

Reserved for adult and child over 4 as this type of anaesthesia is unsuitable before this age.

#### Dose

##### Adult

The quantity to be injected will be adapted according to the importance of the intervention.

Do not exceed the dose of 300mg of lidocaine hydrochloride per session.

##### Elderly subject

Administer half of the dose indicated for adults.

##### Pediatric population

##### Child (over 4)

The quantity to be injected depends on the child's age, weight and the type of procedure performed.

The maximum dose to predict is 20 to 30mg of lidocaine hydrochloride per session.

Do not exceed 2.2mg of lidocaine hydrochloride per kilogram of body weight.

#### Mode of administration

LOCAL OR REGIONAL INTRA-ORAL SUBMUCOSAL INJECTION.

Verify the absence of vascular effraction by repeated aspiration tests, particularly during regional anaesthesia (nerve blocks).

The injection rate must not exceed 1ml

of solution per minute.

### 4.3 Contraindications

This medicinal product is contraindicated in the case of hypersensitivity to local anaesthetics or to any of the constituents, and in the following situations:

- Severe disorders of atrioventricular conduction without a pacemaker.
- Epilepsy not controlled by treatment
- Intermittent acute porphyria.

### 4.4 Special warnings and precautions for use

#### Special warnings

Anaesthesiophagy risks: all kind of bites (lips, cheeks, mucous, tongue); advise patients to avoid the use of chewing gum or eating food as long as the insensibility persists.

Avoid injection into infected and inflamed areas (decreased efficacy of the local anaesthetic).

Sportsmen will be advised that this medicinal product contains an active substance that can cause a positive reaction on anti-doping control tests.

#### Pediatric population

The use of this product is not recommended in children under the age of 4 years, as this type of anaesthesia is unsuitable before this age.

#### Precautions for use

The use of this product requires imperatively:

- to conduct a clinical interview to determine the clinical context, concomitant treatments and the patient's history;
- to perform a test injection of 5 to 10% of the dose in case of allergic risk,
- to perform the injection slowly and strictly outside of the vessels, verifying by repeated aspirations,
- to maintain verbal contact with the patient.

Increased surveillance is required in subjects treated with anticoagulants (surveillance of the INR).

Doses of lidocaine may need to be decreased in the case of severe hepatic insufficiency, due to the mainly hepatic metabolism of amide local anaesthetics. The dosage must also be decreased in the case of hypoxia, hyperkalaemia or metabolic acidosis.

#### 4.5 Interactions with other drugs or other interactions

Not applicable.

#### 4.6 Fertility, pregnancy and breastfeeding

##### Pregnancy

No reliable animal teratogenesis data are available.

In clinical practice, analysis of a large number of pregnancies exposed to lidocaine did not reveal any particular foetotoxic or malformative effect for lidocaine. However, only epidemiological studies can confirm the absence of risk. Consequently, the use of lidocaine can be prescribed for odonto-stomatology indications during pregnancy, only if necessary.

#### Breastfeeding

Like other local anaesthetics, lidocaine diffuses into breast milk in very small quantities; however, breastfeeding can be continued following the anaesthetic procedure.

#### 4.7 Effects on ability to drive and use machines

XYLOROLLAND SANS

VASOCONSTRICTEUR has a moderate influence on the ability to drive and use machines.

#### 4.8 Side effects

Due to the presence of sodium metabisulphite, risk of allergic reactions, as well as anaphylactic reactions and bronchospasms.

Like with all the anaesthetics used in odonto-stomatology, lipothymies can happen.

In the case of overdose or in certain predisposed patients, the following clinical signs may be observed:

- on the central nervous system: nervousness, agitation, yawning, tremor, apprehension, nystagmus, logorrhoea, headache, nausea, ringing in the ears. In the presence of these warning signs, the patient must be asked to hyperventilate, and attentive surveillance is required to prevent possible deterioration with seizures followed by CNS depression.
- on the respiratory system: tachypnoea, then bradypnoea, possibly leading to apnoea.
- on the cardiovascular system: tachycardia, bradycardia, cardiovascular depression with arterial hypotension, possibly leading to collapse, arrhythmias (premature ventricular complexes, ventricular fibrillation), disorders of conduction (atrioventricular block).

These cardiac manifestations can lead to cardiac arrest.

#### Reporting of suspected side effects

The reporting of suspected side effects after approval of the medicinal product

is important. It allows continuous monitoring of the benefit/risk ratio of the medicinal product. Health professionals declare any suspected side effects through the national reporting system.

### 4.9 Overdose

Toxic reactions, reflecting overdose of local anaesthetic, can occur in two situations: either immediately, due to relative overdose resulting from accidental intravenous injection, or more delayed, corresponding to true overdose due to the use of an excessive quantity of anaesthetic.

#### Action in case of overdose

As soon as warning signs are observed, ask the patient to hyperventilate, place the patient in the supine position, when necessary. In the case of clonic seizures, oxygenation injection of a benzodiazepine.

Treatment may require intubation with assisted ventilation.

### 5- PHARMACOLOGICAL PROPERTIES

#### 5.1 Pharmacodynamic properties

Pharmacotherapeutic class: **LOCAL ANAESTHETICS**,

ATC Code: **N01BB02**

#### Mechanism of action

Lidocaine hydrochloride is an amino-amide local anaesthetic, which blocks propagation of the nerve impulse along the nerve fibre at the site of injection. Anaesthesia is obtained within 2 to 3 minutes. The duration of anaesthesia allowing the surgical procedure is about 90 to 120 minutes and 5 to 10 minutes on the pulp.

#### 5.2 Pharmacokinetic properties

##### Distribution

When injected into the oral mucosa, lidocaine reaches a peak blood concentration about 10 to 15 minutes after injection.

##### Elimination

The mean elimination half-life of lidocaine hydrochloride is about 90 minutes.

Lidocaine hydrochloride is mainly metabolised in the liver; 5 to 10% of the dose are eliminated under unchanged form in the urine.

#### 5.3 Preclinical safety data

Studies carried out on animals have demonstrated the good tolerance of lidocaine. Like other amide local anaesthetics, high doses of the active substance can induce toxic reactions on the central nervous system and/or on the cardiovascular system (see section 4.8).

**6- PHARMACEUTICAL DATA****6.1 List of excipients**

Sodium chloride, sodium metabisulphite, sodium hydroxide, water for injections.

Inertizing gas: nitrogen

**6.2 Incompatibilities**

In the absence of compatibility studies, this medicinal product should not be mixed with other medicinal products.

**6.3 Shelf life**

Before opening: 3 years.

After opening: the product must be used immediately.

**6.4 Special storage precautions**

Store at a temperature below +25°C and away from light.

**6.5 Nature and content of external packing**

1.8ml in cartridge (type I colourless glass) with a stopper (bromobutyl) and capsule (aluminium) with joint (bromobutyl). Box of 50.

**6.6 Special precautions for disposal and handling**

Like for all cartridges, the diaphragm will be disinfected just before use. It will be carefully plugged:

- either with ethyl alcohol at 70%,
- or with pure isopropyl alcohol at 90% for pharmaceutical use.

The cartridges must never be plunged in any solution.

Do not mix the injectable solution with other products in the same syringe.

Any opened cartridge of anaesthetic solution must not be re-used.

**7- HOLDER OF THE MARKETING AUTHORIZATION**

PRODUITS DENTAIRE PIERRE ROLLAND

ZI du Phare - 17 avenue Gustave Eiffel - 33700 MERIGNAC

**8- FRENCH REGISTRATION ID NUMBER**

CIP 34009 500 219 1 4: 1.8ml in cartridge (glass) with a stopper (bromobutyl); box of 50.

**9- DATE OF FIRST****AUTHORIZATION/OF RENEWAL OF AUTHORIZATION IN FRANCE**

Date of first authorization:

18<sup>th</sup> September 1997

Date of last renewal:

18<sup>th</sup> September 2007

**10- DATE OF TEXT UP-DATING IN FRANCE**

19<sup>th</sup> February 2019

**CONDITIONS OF PRESCRIPTION AND DELIVERY IN FRANCE**

List II

Medicinal product reserved for professional use according to article R.5121-80 of the French public health code.





**17 avenue Gustave Eiffel  
ZI du Phare  
33700 MERIGNAC  
France**

**Tel: +33 (0) 556 340 607  
Fax: +33 (0) 556 349 292  
info@acteongroup.com**

Follow-us



Non contractual document -  
Copyright © 2024 ACTEON®. All rights reserved. No  
information or part of this document may be reproduced  
or disclosed in any format without the prior authorisation  
of ACTEON®.

For professional dental use only.

Read the instructions in the notice carefully before use.

All information that is essential to ensure correct use  
of these devices is included in the user manual or the  
summary of the product characteristics available on  
[www.acteongroup.com](http://www.acteongroup.com).

Updated on: February 2024